



IFM-GEOMAR

Leibniz-Institut für Meereswissenschaften
an der Universität Kiel

RV Atalante
Fahrtbericht / Cruise Report
MARSUED IV
(replacement of MSM06/3)

Recife, Brazil - Dakar, Senegal

07.01. - 31.01.2008

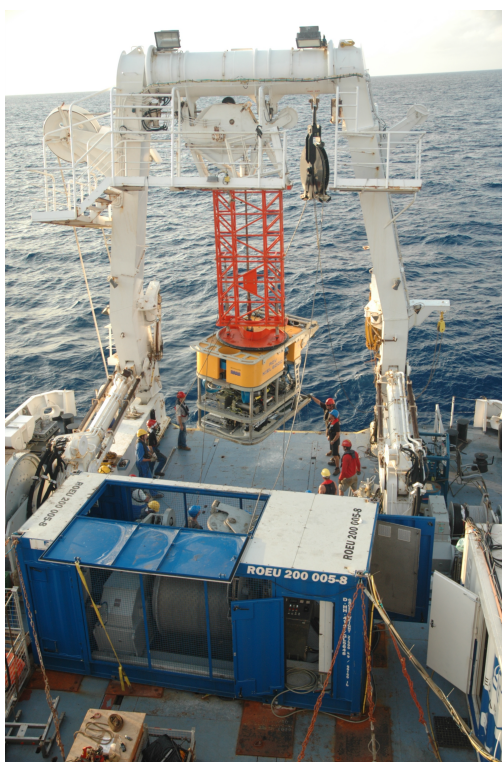

Berichte aus dem Leibniz-Institut
für Meereswissenschaften an der
Christian-Albrechts-Universität zu Kiel

Nr. 23
September 2008



IFM-GEOMAR

Leibniz-Institut für Meereswissenschaften
an der Universität Kiel

RV Atalante Fahrtbericht / Cruise Report MARSUED IV (replacement of MSM06/3)

Recife, Brazil - Dakar, Senegal

07.01. - 31.01.2008

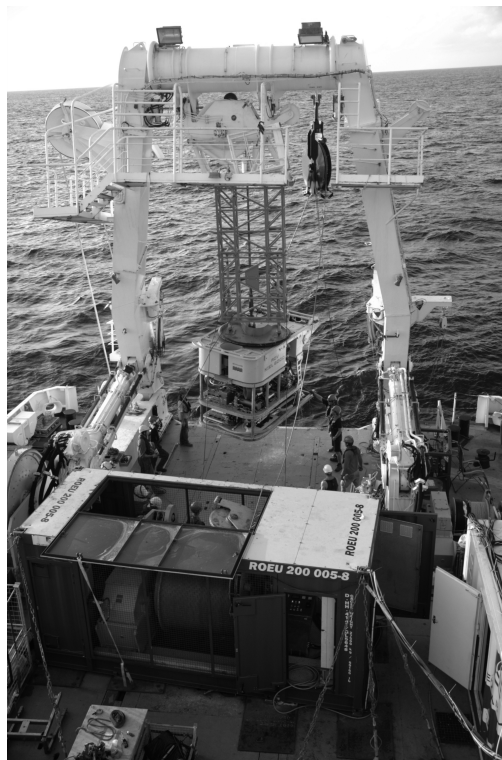

Berichte aus dem Leibniz-Institut
für Meereswissenschaften an der
Christian-Albrechts-Universität zu Kiel

Nr. 23, September 2008

ISSN Nr.: 1614-6298



IFM-GEOMAR

Leibniz-Institut für Meereswissenschaften
an der Universität Kiel

Das Leibniz-Institut für Meereswissenschaften
ist ein Institut der Wissenschaftsgemeinschaft
Gottfried Wilhelm Leibniz (WGL)

The Leibniz-Institute of Marine Sciences is a
member of the Leibniz Association
(Wissenschaftsgemeinschaft Gottfried
Wilhelm Leibniz).

Herausgeber / Editor:

Colin Devey

IFM-GEOMAR Report

ISSN Nr.: 1614-6298

Leibniz-Institut für Meereswissenschaften / Leibniz Institute of Marine Sciences

IFM-GEOMAR
Dienstgebäude Westufer / West Shore Building
Düsternbrooker Weg 20
D-24105 Kiel
Germany

Leibniz-Institut für Meereswissenschaften / Leibniz Institute of Marine Sciences

IFM-GEOMAR
Dienstgebäude Ostufer / East Shore Building
Wischhofstr. 1-3
D-24148 Kiel
Germany

Tel.: ++49 431 600-0
Fax: ++49 431 600-2805
www.ifm-geomar.de

Contents

2.1	Participants.....	3
2.2	Research Program	5
2.3	Cruise Narrative	9
2.4	Preliminary Results	10
2.4.1	Physical Oceanography.....	10
2.4.1.1	Instruments and Methods.....	10
2.4.1.2	First results.....	12
2.4.2	Microbiology from low-temperature, diffuse and hot hydrothermal fluids	16
2.4.3	Temperature measurements of low-temperature, diffuse hydrothermal fluids	24
2.4.4	Fluid chemistry	28
2.4.4.1	Fluid sampling	28
2.4.4.2	Analytical procedures on-board.....	32
2.4.4.3	First results.....	34
2.4.4.4	The chemical composition of hydrothermal fluids – Perspectives	42
2.4.5	Gas Chemistry.....	42
2.4.6	Hydrothermal Symbioses.....	46
2.4.7	Paleoceanography.....	50
2.4.8	Global distribution and atmospheric transport of volatile and semi-volatile polyfluorinated compounds	52
2.4.9	Volcanic rocks.....	52
2.4.10	Rocks from the deeper crust.....	58
2.4.11	ROV deployments during MAR SOUTH IV	67
2.5	Acknowledgements.....	68
2.6	References.....	69
	Appendix	71

2.1 Participants

1.	Prof. Colin Devey	Chief Scientist	IFM-GEOMAR
2.	Dan Cormany	ROV Pilot	High Sierra Technologies
3.	Dr. Nicole Dubilier	Hydroth. Symbioses	MPI Bremen
4.	Gerd Fraas	Phys. Oceanography	Univ. Bremen
5.	Andy Foster	ROV-Team	Schilling Robotics
6.	Dieter Garbe-Schönberg	Fluid Chemistry	Univ. Kiel
7.	Petra Günnewig	Phys. Oceanography	Univ. Bremen
8.	Phillip Hach	Fluid Chemistry	Jacobs Univ. Bremen
9.	Almuth Harbers	Palaeoceanography	IFM-GEOMAR
10.	Claus Hinz	ROV-Team	IFM-GEOMAR
11.	Verena Klevenz	Fluid Chemistry	Jacobs Univ. Bremen
12.	Jürgen Koepcke	Petrology	Univ. Hannover
13.	Eric Labahn	ROV-Team	Fa. K.U.M.
14.	Klas Lackschewitz	ROV-Team	IFM-GEOMAR
15.	Ralf Lendt	Gas Chemistry	Univ. Hamburg ⁺
16.	Nadine Markus	Microbiology	Univ. Hamburg*
17.	Arne Meier	ROV-Team	IFM-GEOMAR
18.	Bernd Melchert	Bathymetry	IFM-GEOMAR
19.	Christian Mertens	Phys. Oceanography	Univ. Bremen
20.	Holger Paulick	Petrology	Univ. Bonn
21.	Mirjam Perner	Microbiology	Univ. Hamburg*
22.	Martin Pieper	ROV-Team	IFM-GEOMAR
23.	Katja Schmidt	Fluid Chemistry	Jacobs Univ. Bremen
24.	Jörg Schneider	ROV-Team	IFM-GEOMAR
25.	Richard Seifert	Gas Chemistry	Univ. Hamburg ⁺
26.	Harald Strauss	Fluid Chemistry	Univ. Münster
27.	Jillian Struck	Hydroth. Symbioses	MPI Bremen
28.	Günter Suhr	Petrology	Univ. Cologne
29.	Frederic von Guilleaume	Gas Chemistry	Univ. Hamburg ⁺
30.	Marco Warmuth	Gas Chemistry	Univ. Hamburg ⁺

Participating Institutions**IFM-GEOMAR**

Wischhofstr. 1-3
24148 Kiel

MPI Bremen

Max-Planck-Institut for Marine Microbiology
Celsiusstr. 1
28359 Bremen

University of Kiel

Institut für Geowissenschaften
Olshausenstr. 40
24118 Kiel

University Bremen

Fachbereich 1 "Environmental physics"
Postfach 330440
28334 Bremen

Jacobs University Bremen

PO Box 750561
28725 Bremen

University Hannover

Institut für Geowissenschaften
Welfengarten 1
30167 Hannover

University of Cologne

Institut für Geologie und Mineralogie
Zülpicher Str. 49 a/b
50674 Köln

University of Hamburg*

Department of Biology, Biozentrum Klein
Flottbek
Ohnhorststr. 18
22609 Hamburg

University of Hamburg+

Institut für Biogeochemie und Meereschemie
Bundesstraße 55
20146 Hamburg

University of Münster

Geologisch-Paläontologisches Institut
Corrensstraße 24
48149 Münster

University of Bonn

Mineralogisches und Petrologisches
Poppelsdorfer Schloss
53115 Bonn

Schilling Robotics

201 Cousteau Place
Davis, CA., 95618
U.S.A.

High Sierra Technologies

40940 Baptist Church Drive
Lebanon, Oregon, 97355
U.S.A.

2.2 Research Program

The research cruise had, in the time available, two major aims: returning to observe and sample at the 4°48'S hydrothermal site (Turtle Pits etc.) and observing and sampling the lower crust on the 5°S Inside Corner High. The following gives some details on these goals:

4°48'S (Turtle Pits, Red Lion, Wideawake Field)

Vents at Turtle Pits (location, Fig. 2.2.1) show turbulent fluid emanations with temperatures of about 400°C. This is the highest temperature measured so far in fluids at the MAR. Consequently, the system is close to the critical point of seawater on the two-phase boundary

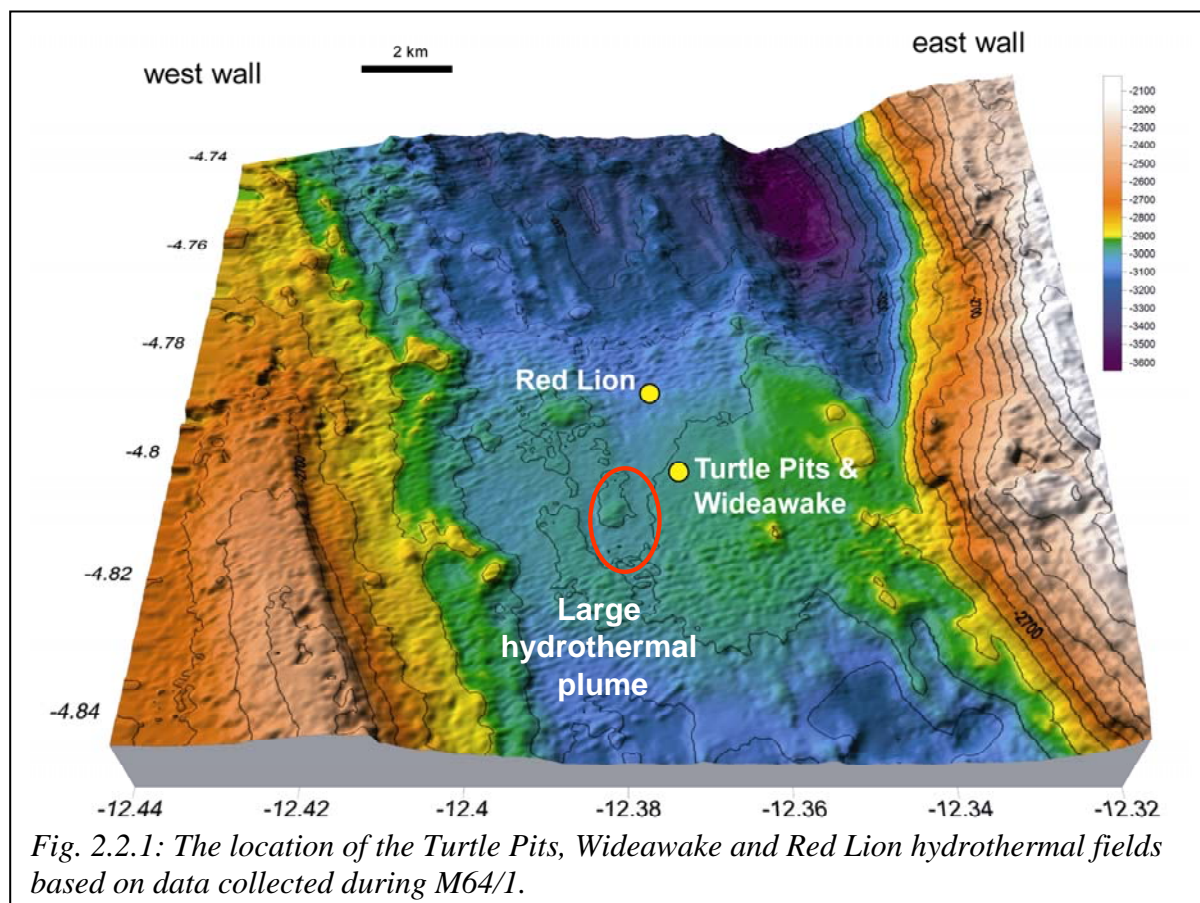

Fig. 2.2.1: The location of the Turtle Pits, Wideawake and Red Lion hydrothermal fields based on data collected during M64/1.

for a boiling system. The Turtle Pits boiling fluids have significantly reduced chloride concentrations (end member value of 254 mmol/l Cl, Fig. 2.2.2) compared to a background bottom seawater value of about 560 mmol/l Cl. This indicates that the fluids are phase-separated and that the samples collected represent the vapour-type phase in the boiling fluids. The diffuse-flow Wideawake mussel field, which is located at a distance of only a few hundred meters from Turtle Pits, is on the same mixing line of seawater and hydrothermal end member chlorinity (Fig. 2.2.2), indicating that Turtle Pits and Wideawake are supplied from the same fluid source at depth. Interestingly, the fluids from the Red Lion field apparently do not show any signs of phase separation (chlorinity end member of 563 mM undistinguishable from seawater, Fig. 2.2.2). Although we have no in-situ temperatures from the Red Lion vents, we can deduce that the Red Lion fluid source at depth has a significantly lower temperature than at Turtle Pits. The high Fe/Mn ratio of 6.8 at Turtle Pits is as high as it is documented for ultramafic systems such as Rainbow and Logatchev fields (Douville et al., 2002) and contrasts with a Fe/Mn ratio of 1 in the Red Lion fluids.

The Turtle Pits fluids have a very high H₂/CH₄ ratio of about 15, even exceeding those found in the serpentinite-hosted Logatchev and Rainbow hydrothermal vents (see data for cruise

M60/3 and from Douville et al., 2002). In contrast, the H_2/CH_4 ratio at Red Lion is only 2.7. Dissolved sulphide concentrations for the three individual hydrothermal vent sites at 5°S are quite variable, ranging from a low abundance of 3 $\mu\text{mol/l}$ (measured data) in the diffuse fluids at the Wideawake Mussel Field to concentrations as high as 830 $\mu\text{mol/l}$ (measured; endmember 1.3 mM) for hot fluids emanating from black smokers at the Turtle Pits site.

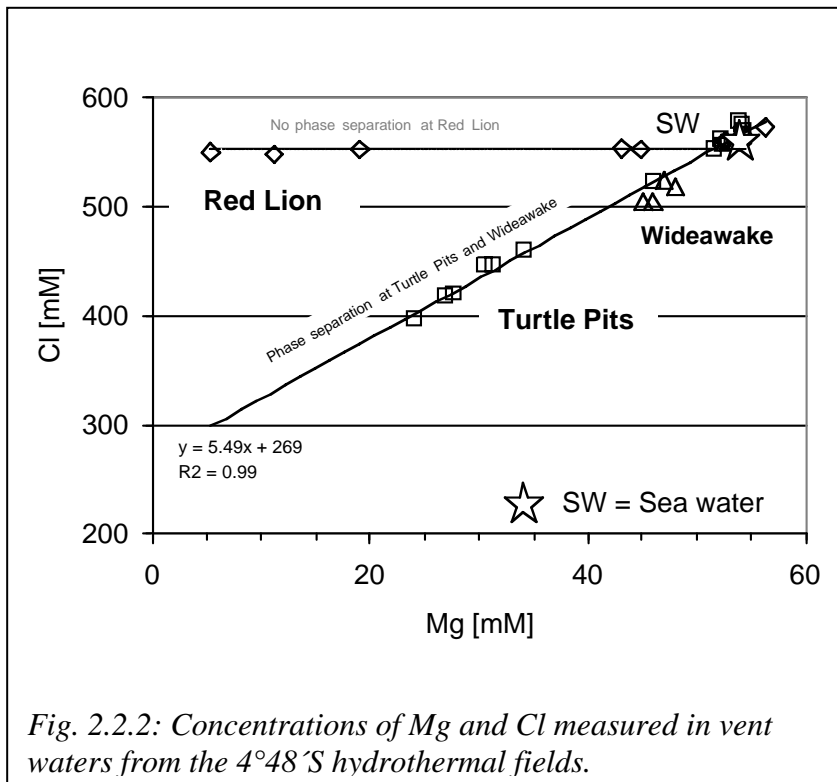

Fig. 2.2.2: Concentrations of Mg and Cl measured in vent waters from the 4°48'S hydrothermal fields.

progress, microscopic observations of microorganisms from the Wideawake field revealed heterogeneous morphological assemblages in most cases. Interestingly, enough rock samples collected at the border of Bathymodiolus assemblages showed white structures (0.5-2 mm length) which covered the entire rock and could easily be recognized by eye. Morphological these cells had the typical features of Thiothrix species. In addition, some netlike cracks were observed which were dominated by a large coccoid microorganism (20 μm width) with obvious similarity to species of Achromatium. Both microorganisms contained numerous sulphur globules and represent members of the group of colorless sulphur bacteria. Both microorganisms are important primary producers and are highly abundant at these vent sites. To our knowledge, this is the first observation of these two colorless sulphur bacteria at deep sea hydrothermal vent systems.

Lower crustal and mantle rocks in the spreading axis

Decompression melting of adiabatically upwelling mantle is probably the cause of most magmatism at the mid-ocean ridges (e.g. Klein and Langmuir, 1987). At most ridges, the lower crust and upper mantle are therefore difficult to study as they are coated by and buried beneath 2+ km of dikes and lavas. At slower spreading rates, however, the adiabatic melting process can start to become heterogeneous and rocks from the lower crust and mantle start to become more accessible.

This occurs through two processes. Firstly, the mantle produces generally less melt and this melt production becomes focussed towards the spreading segment centres as a result of 3-D upwelling (Parmentier and Morgan, 1990). The „crust“ is then made up of a mixture of basalt

and mantle rocks, the latter of which may contain intrusives such as gabbros (e.g. Cannat, 1996; Cannat et al., 1992; Cannat et al., 1995). Secondly, the increasing importance of tectonic processes in accommodating the spreading movement at magma-starved slower spreading ridges can lead to the formation of low-angle normal faults (Cann et al., 1997). These faults generate tectonic windows which can provide the necessary exposures of the lower crust and mantle (Tucholke et al., 1998). They can lead to the formation both of so-called „megamullions“ (areas of striated seafloor close to the ridge axis reflecting the slip surface of the low-angle normal faults) and also of inside corner highs (areas of raised

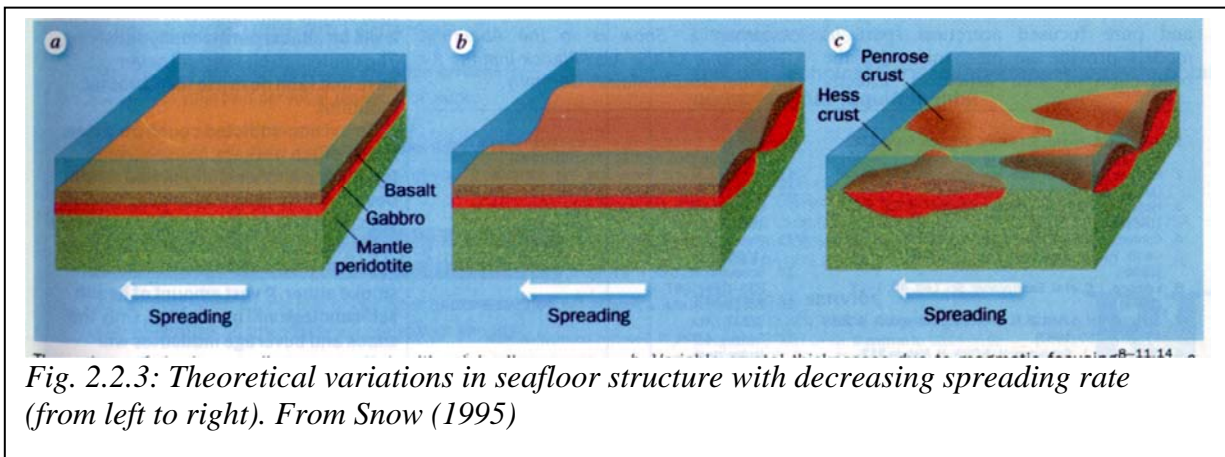

Fig. 2.2.3: Theoretical variations in seafloor structure with decreasing spreading rate (from left to right). From Snow (1995)

bathymetry on the inner side of a spreading axis – transform boundary). These low-angle detachment faults may be rooted above a shallow magma chamber, or even cut all the way into the mantle rocks. Baines et al. (2003) showed that the uplift of “inside corner highs” is partially caused by transpressional forces of large faults around them.

The seafloor generated at slow-spreading ridges (Fig. 2.2.3, c) is therefore in principle vastly different to that generated at fast-spreading ridges (Fig. 2.2.3, a).

This could have enormous implications for hydrothermal processes, as the nature of the rock in which the hydrothermal system is rooted is of paramount importance for the composition of the hydrothermal fluids. This point was made forcibly by the serendipitous discovery of a hydrothermal system situated on, and deriving all its energy from, ultramafic (mantle) rocks at the Lost City site in the Atlantic (Kelley et al., 2001).

The low-angle normal faults also bring samples from great depth up to the seafloor. This

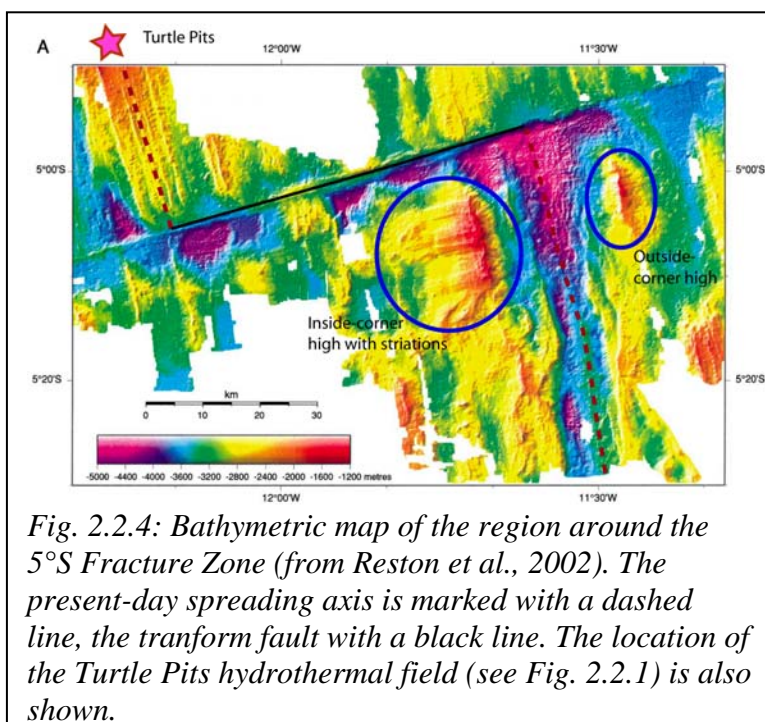

Fig. 2.2.4: Bathymetric map of the region around the 5°S Fracture Zone (from Reston et al., 2002). The present-day spreading axis is marked with a dashed line, the transform fault with a black line. The location of the Turtle Pits hydrothermal field (see Fig. 2.2.1) is also shown.

allows us almost unique access to rocks from the lower crust and upper mantle influenced by the hydrothermal circulation operating at very high temperatures at the interface between magmatic and hydrothermal processes. The geological record of this process was discovered in many gabbros from the Kane Fracture zone at the MAR, 23°N (Koepke et al., 2005b) and also from the Atlantis II core complex of the slow-spreading Southwest Indian Ridge (Koepke et al., 2005a; Koepke et al., 2004). These authors found evidence to support the hypothesis that seawater-derived water-rich fluids

propagate along high-temperature shear zones down into the deep oceanic crust causing locally hydrous partial melting on grain boundaries. This results in the formation of a characteristic interstitial mineral paragenesis and a SiO₂-rich melt which may separate and crystallize within cracks forming typical felsic veins or netveining matrices. With the help of a newly developed in-situ Sr isotope technique it was recently verified that the fluids triggering the partial melting are seawater-derived. Thus, the observed fluid/melt transport in the deep oceanic crust within core complexes represents a first and fundamental stage in the transfer of heat from the crust to the surface.

Two areas in which lower crustal and mantle rocks are exposed are known from previous work in the MARSUED-area. Geophysical and rudimentary sampling studies south of a small fracture zone at 5°S (Reston et al., 2002) have shown the presence of both gabbros and serpentinites on a so-called inside-corner high. This high appears to have been split in relatively recent times (0.75 Ma) by rifting, forming a new axis in the middle of the uplifted block and generating a complimentary outside-corner high (see Fig. 2.2.4).

Four dredges collected by Reston during M47/2 showed that the inside-corner massif is predominantly made of gabbroic intrusive rocks, although serpentinitised peridotites were found on the corrugated upper surface of the massif, probably associated with smearing along the detachment fault. These authors suggest that detachment faulting and uplift of lower crustal and mantle rocks may be occurring concurrently with magmatic rifting (see Fig. 2.2.5). This situation may be exactly the one which is needed to explain the types of hydrothermal activity seen at the other SPP site at Logatchev and perhaps even at Nibelungenfeld, where fluids with temperatures which require them to have been in close contact with magmas are vented in areas of the seafloor characterised by lower crustal or mantle rocks.

One of the major aims of the cruise proposed here will be to study this uplifted massif to determine (a) its geology and the distribution of rock types and (b) to look for the distribution of alteration channels which may have been former root zones for hydrothermal systems.

Reston et al.'s (2002) observation of gabbronorite among the plutonic rocks of the inside corner high is significant, since the dominance of orthopyroxene primocrysts in primitive gabbros indicates crystallization and fractionation at depth, several km deeper than that level where the axial magma chambers under ridges are typically located. For example, high amounts of gabbronorites were recovered farther north, between 14° - 16°N by both M60/3 and the ODP (Ocean Drilling Program, Leg 209) recording cooling and partial crystallization of ascending MORB at great depth (15–25 km). Moreover, crystallization and fractionation of MORB magmas at depth is also in agreement with phase equilibria modelling in combination with experimental work based on the dredged basalts of different segments of the MARSUED area, revealing different equilibrium pressures for individual segments between 1.5 and 8

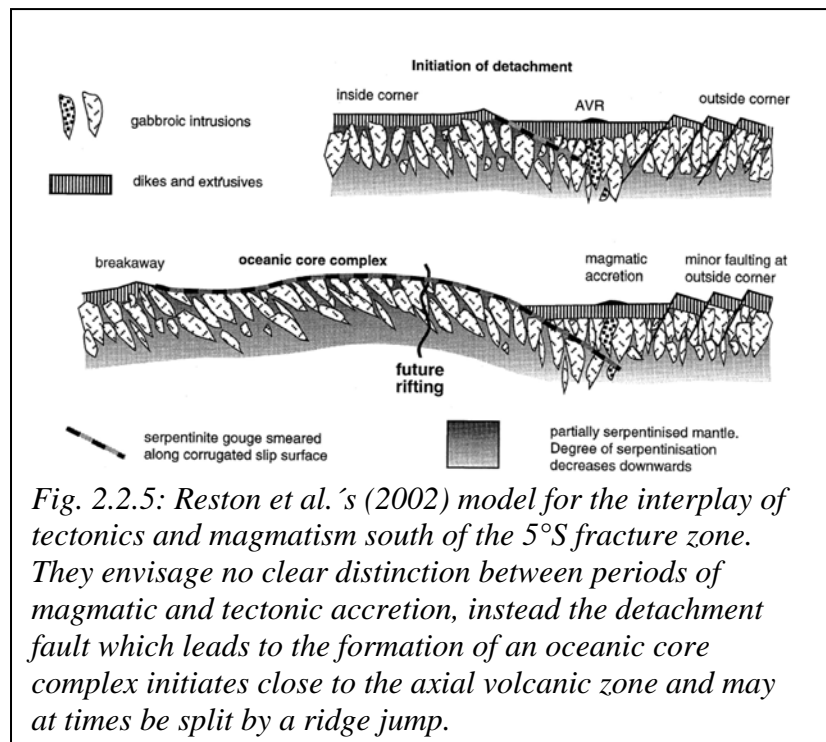

Fig. 2.2.5: Reston et al.'s (2002) model for the interplay of tectonics and magmatism south of the 5°S fracture zone. They envisage no clear distinction between periods of magmatic and tectonic accretion, instead the detachment fault which leads to the formation of an oceanic core complex initiates close to the axial volcanic zone and may at times be split by a ridge jump.

kbar. These results show also that the differentiation under distinct segments was strongly influenced by water activity.

2.3 Cruise Narrative

The N.O. "Atalante" left Recife harbour on schedule in the morning of 7th January 2008. There followed a 7 day transit to the working area, including a stop to lower the ROV cable to 5500m to remove twists in the wire. The ship arrived in the working area late in the evening of 13th January and the research program started with CTD stations to establish the strength and position of any hydrothermal plume. This was the beginning of activities which repeated each day – a night program consisting of CTD work or rock sampling with the volcanic corer interspersed with a day program of ROV dives. Whenever the ROV needed maintenance the day program consisted of mapping or longer CTD stations. The penultimate day of the working period was marked by an attempt (unfortunately unsuccessful) to recover releasers from the University of Bremen mooring which did not surface followed by the deployment of a profiling mooring from IFM-GEOMAR. The last day saw a long dive on the fracture zone wall at 5°S. Early in the morning of 26th January the ship left the working area on course for Dakar where we docked at 08:00 on 31st January 2008.

2.4 Preliminary Results

2.4.1 Physical Oceanography

(C. Mertens, G. Fraas, P. Günnewig)

2.4.1.1 Instruments and Methods

Conductivity-temperature-depth (CTD) casts were carried out using a Sea-Bird Electronics, Inc. SBE 911plus system (IFM-GEOMAR) that was equipped with double temperature, conductivity, and oxygen sensors as well as with a Wetlab C-Star transmissometer (D. Quadfasel, Univ. Hamburg). The underwater unit was attached to a SBE 32 carousel water sampler with 24 Niskin bottles. Three bottles were left out for a lowered acoustic Doppler current profiler system (LADCP), hence a maximum of 21 bottles was used. The complete system worked properly throughout the entire cruise. Salinity samples, typically three on each cast, were collected for later analysis at home. In total 20 CTD casts were carried out, including three time series (yoyo) stations, and one towed transect across the rift valley (Fig. 2.4.1.1).

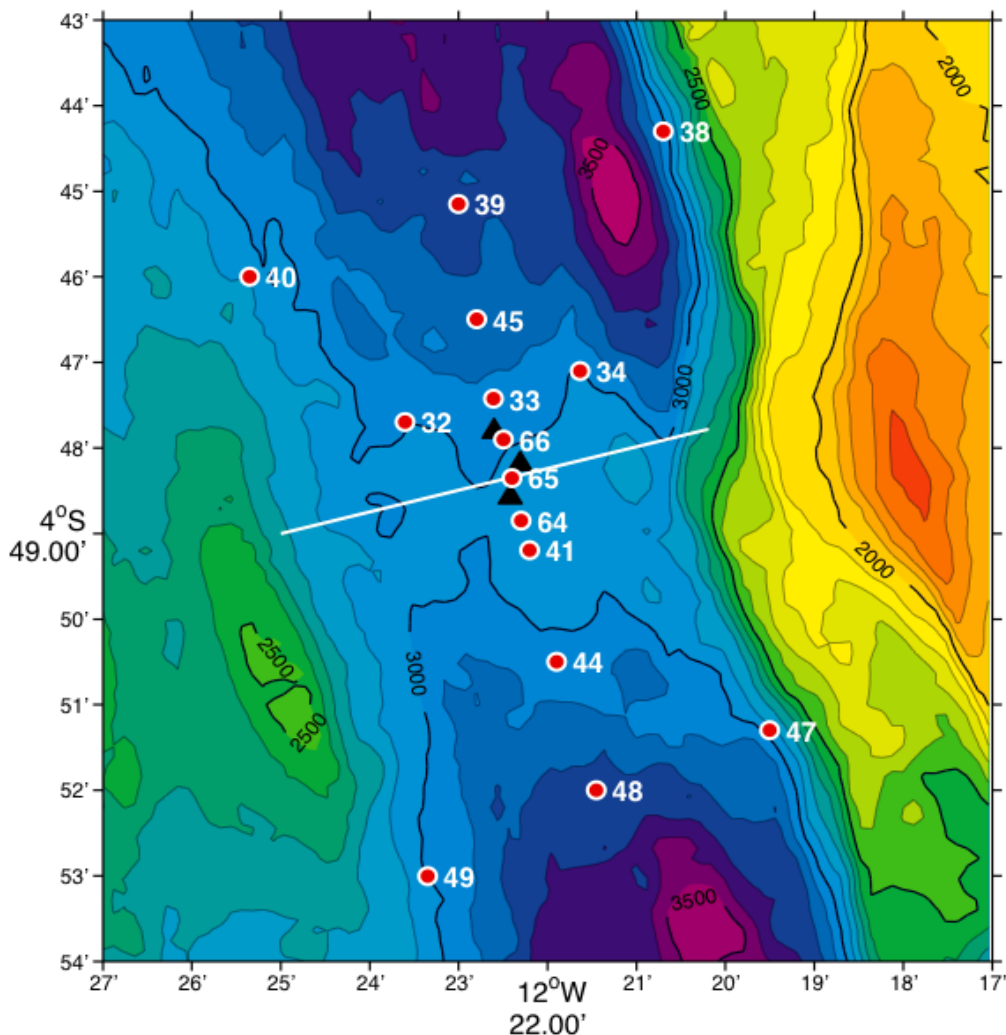

Fig. 2.4.1.1: Map of the working area showing the CTD/LADCP stations (dots). The track of a tow-yo track across the rift valley is shown as a white line. The hydrothermal vent sites Turtle Pits, Comfortless Cove, and Red Lion are depicted as black triangles. Additionally three time series stations were carried out. Two north of Red Lion (at station 33) and one north of Comfortless Cove (near station 66).

The LADCP system consisted of two RD Instruments 300 kHz Workhorse Monitor ADCPs. The instruments worked in a synchronized master-and-slave setup, where the downward looking master (S/N 630, IFM-GEOMAR) triggers the upward looking slave (S/N 7915, Univ. Bremen). The instruments were powered by an external battery supply, that consisted of 35 commercial quality 1.5 V batteries assembled in a pressure resistant Aanderaa housing. On one of the time series stations (62, CTD17) the slave instrument did not collect any data. This was presumably caused by a communication problem between master and slave.

An inverse method incorporating the bottom track velocities was used for the post processing of the raw data. The overall performance of the two instruments was very good: The range of each instrument was typically 150 m in the upper parts of the water column and 60 to 70 m at depth exceeding 1500 m. Thus, the total range of the package reached from 150 to 300 m. With lowering and heaving velocities of 1 m/s of the instrument package, this range amounted to 100 to over 200 estimates of current shear in each depth cell in the deep water, and more in the shallow layers, depending on the amount of backscatter. For the cast with the single instrument, the reduction of range lead to a decrease of shear estimates per bin, but as the water depth did not exceed 3000 m and the abundance of backscatterers was high, the resulting current data were still of good quality.

During yoyo and towyo stations three (serial numbers 33, 36, and 38) miniature autonomous plume recorders (MAPR, E. Baker, NOAA/PMEL) were used to improve the data coverage. MAPRs are self-contained instruments, that record data at pre-set time intervals from temperature (thermistor mounted in a titanium probe, resolution 0.001°C), pressure (0 - 6000 psi gauge sensor, resolution 0.2 psi), and nephelometer (Sea Tech Light Backscatter Sensor, LBSS) sensors. One MAPR (S/N 38) had an additional redox potential (Eh) probe build by K. Nakamura. During operation two of the MAPRs were clamped on the hydrgraphic wire, 100 m and 200 m above the water sampler, and the MAPR with the Eh probe was directly attached to the water sampler. The instruments were working fine throughout the cruise, with only one exception during the cross-valley towyo, were one MAPR (S/N 38) recorded only the first 70% of data. On four CTD stations near the vent sites the MAPR with Eh probe was also attached to the water sampler. In total, MAPRs were used on 9 of the 20 CTD stations.

For measurements of the Helium concentrations and isotopic signature, water samples were taken in the water column from the Niskin bottles (94 samples in total) and directly from the vents with the ROV (3 samples). The samples were sealed free of head space and gas tight in copper tubes (sample volume 40 ml). Special containers for sampling vent fluid (developed & tested in the framework of the SPP 1144) were used for the ROV samples. The sampling containers can keep a pressure of more than $3 \cdot 10^7$ Pa and avoid phase separation of vent fluids and gases. Helium isotope measurements will be carried out at the University of Bremen with a fully automated UHV mass spectrometric system. The sample preparation includes gas extraction in a controlled high vacuum system. Helium and neon are separated from permanent gases in a cryo system at 25 K. A split of the sample is analyzed for ^4He , ^{20}Ne and ^{22}Ne with a quadrupole mass spectrometer. At 14 K He is separated from Ne and released into the sector field mass spectrometer for analysis of ^3He and ^4He . The facility achieves about $\pm 0.2\%$ precision for $^3\text{He}/^4\text{He}$ ratios, and $\pm 0.5\%$ or better for helium and neon concentrations. The primordial components of helium isotopes are ideal tracers for large-scale distribution of vent fluids in the water column. Samples collected during this cruise are supposed to provide the regional distribution of dispersing vent fluids in the water column leading to an estimate of its volume.

On January 14, an attempt was made to recover a mooring with three Aanderaa RCM11 current meters (Univ. Bremen) at $4^\circ 48.21' \text{ S}$, $12^\circ 22.50' \text{ W}$, that was deployed during Meteor cruise M68/1 in May 2006. However, the mooring did not leave the ground, although the release execution command was clearly confirmed during several attempts from both

releasers. Acoustic ranging revealed that the releasers were located at a depth of about 3000 m which is the seafloor depth at this location. It was therefore concluded that the mooring must have lost all buoyancy because the nominal depth of the releasers was 45 m above the seafloor. Knowing the approximate position of the releasers from the acoustic ranging measurements, a recovery dive with the ROV was undertaken in the evening of January 24 to find the two releasers and possibly one of the current meters. During the dive an area of about 150 m x 100 m was searched but (probably because of the rough terrain) the instruments could not be found.

A new mooring equipped with a CTD profiler and an acoustic current meter (IFM-GEOMAR) was deployed at nearly the same location as the previous mooring. The instrument was programmed to carry out 11 profiles between 2295 dbar and 2990 dbar every 5 days. The deployment started on January 24, 23:10 with the anchor first. The top buoy went into the water on January 25, 01:18. Afterwards the mooring was carefully lowered towards the seafloor and acoustically released as the anchor was 15 m above the ground at 02:55. The position of the anchor drop was $4^{\circ} 48.20' \text{ S}$, $12^{\circ} 22.51' \text{ W}$ and the water depth 3004 m.

2.4.1.2 First results

Two hydrographic sections with 3 casts each (CTD/LADCP/Water sampling/48 Helium samples) were carried out north (CTD6-CTD8) and south (CTD13-CTD15) of the area. The local topography is closed to the sides below a water depth of 2700 m, hence these two sections form a box where measurements of the current field and the stratification allow to calculate fluxes of volume, heat and helium into and out of the vent field area. A third section, again with 3 casts (CTD2-CTD4, 34 Helium samples) was carried out directly north of the Red Lion vent site. Six additional CTD stations (CTD9, CTD11, CTD12, CTD18-CTD20) were used to close an along-valley section (including 13 on stations 11 and 12). Three time series stations (yoyo) were carried out; two north of Red Lion (CTD5 and CTD17) and one north of Comfortless Cove (CTD16). Finally a 5 nm long tow-yo transect completely covering the deep part of the axial valley below the maximum plume height. During the tow-

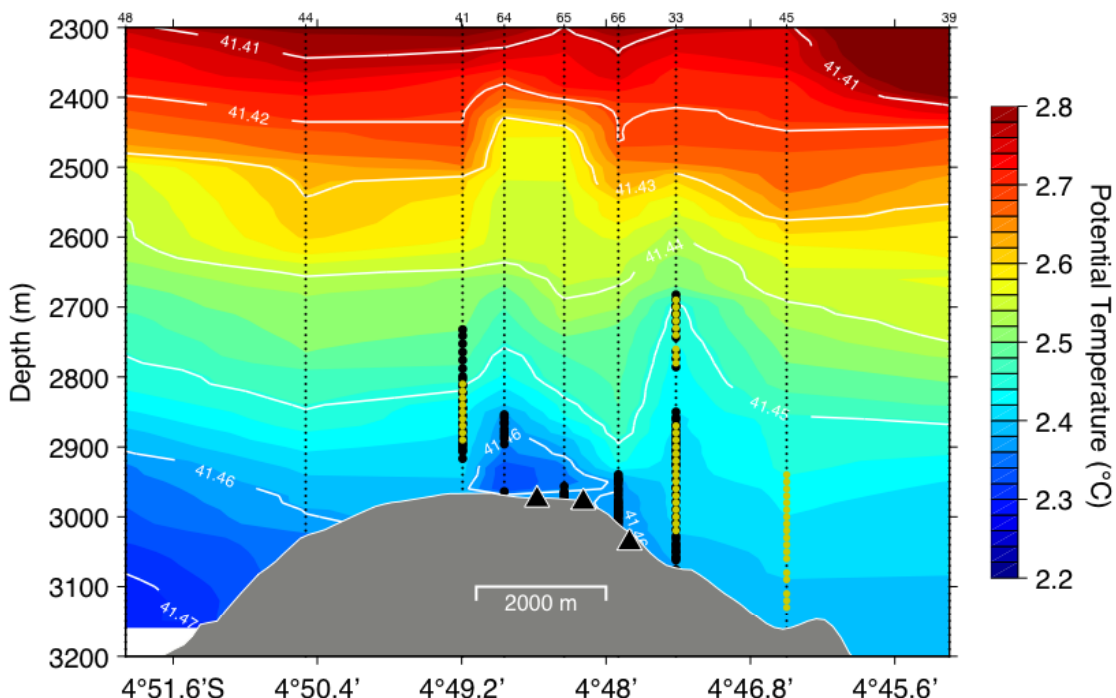

Fig. 2.4.1.2: Potential temperature section along the rift valley put together from nine non-synoptic CTD stations. Contours of potential density are shown in white. Transmission and Eh anomalies are marked with yellow and black dots (no Eh data on station 45). The locations of the vent sites are indicated by black triangles.

yow, POSIDONIA was used to navigate the CTD.

The along-valley temperature and density structure (Fig. 2.4.1.2) clearly indicates a mean northward flow, as the water below sill level is colder and denser on the southern side. Downstream of the sill, the isotherms and isopycnals (and hence the plume anomalies) deepen, showing that water spills over the sill, and the water column stretches, i.e. the vertical spacing between isopycnals increases. Plume signals, either transmission or Eh anomalies, were found at all stations close to the vent sites (33, 41, 45, 64-66) up to a depth of about 2700 m. The distance from the vent sites where plume signals are still found in the water column is larger in northward than in southward direction which indicates prevailing northward currents in the plume layer. Interestingly, Eh signals were found on three stations (64-66) rather close to the vent sites but no indications for the particle plume, neither in the transmissometer data nor in the backscatter measurements of the MAPR. Above the sill the isopycnals show large vertical excursions of up to ± 100 m caused by tides and internal waves.

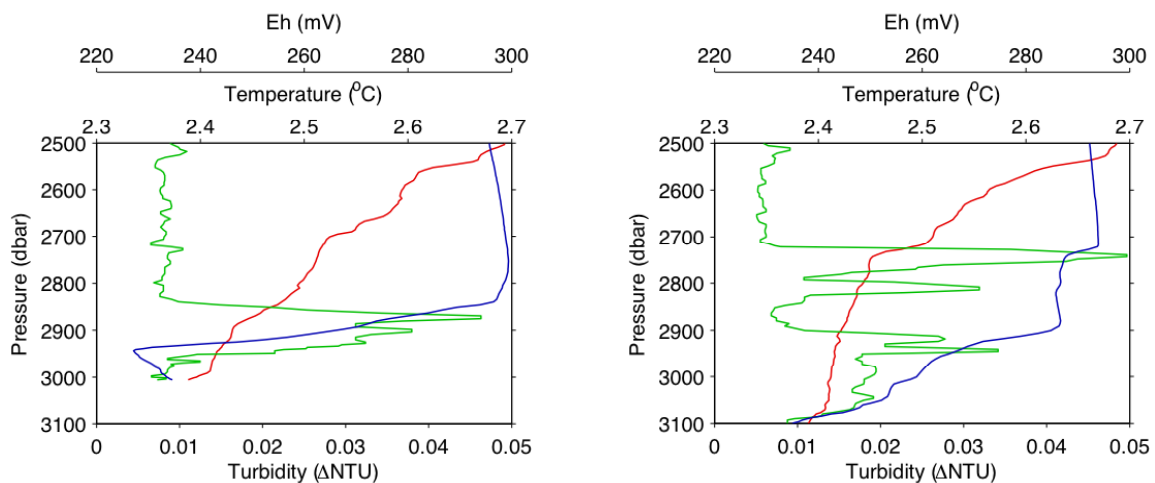

Fig. 2.4.1.3: Vertical MAPR profiles of temperature (red), turbidity (green), and Eh (blue) at two stations south (station 41, left) and north (station 33, right) of the vent sites.

The maximum rise height of the plume corresponds roughly to the 2.5 °C isotherm, observed at the stations 33 and 41. The MAPR data at these two stations are shown in Fig. 2.4.1.3. At the southern station a single plume between 2800 and 2950 m was observed. At the northern station the vertical structure of turbidity and Eh reveal an upper plume between 2700 and 2850 m, followed by a second plume between 2900 and 3000 m. The decrease in Eh in the upper plume is smaller compared to the second plume and therefore the water in upper plume is farther away from the source and probably originating from the Turtle Pits vent site. Below 3050 m a third decrease in Eh is observed again smaller than in the second plume, suggesting Comfortless Cove as the source. The central plume with the strongest Eh signal should therefore be attributed to the Red Lion vent site.

Detailed measurements of the plume variability were obtained during two time series stations (yoyo) carried out about 700 m north of the Red Lion vent site. The first yoyo was on January 14/15 with a duration of 9 hours and the second was about 8 days later on January 22/23. The time series of turbidity (Fig. 2.4.1.4) show a large variability of the particle plume. During the first yoyo stations two distinct maxima were observable, although changing in depth and intensity with time. These two maxima could be attributed to Turtle Pits (upper) and Red Lion (lower). The lowest plume that originates from Comfortless Cove starts to appear after 4-5 hours between 3000 and 3050 m. The vertical excursions of the plumes can be explained by internal waves, as the plume clearly follows the isotherms.

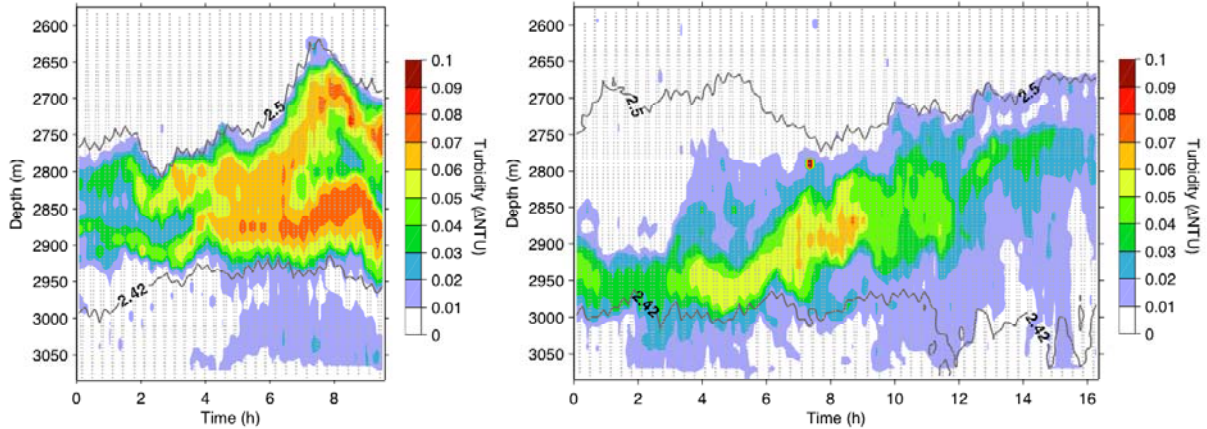

Fig. 2.4.1.4: Time series of turbidity measured during two yoyo stations carried out on January 14/15 (left) and January 22/23 (right), both at the same location about 700 m north of the Red Lion vent field (at station 33 in Fig. 2.4.1.1). Also shown are two temperature contours that depict the upper and lower boundaries of the non-buoyant plume.

During the second yoyo the turbidity measurements suggest a slowly rising single plume, which makes physically no sense in a non-buoyant plume. Instead the variability of the currents has to be taken into account which show a nearly constant northward flow and tidal fluctuations of ± 4 cm/s in east-west direction (Fig. 2.4.1.5). Therefore the path of the particles from the source to the observational site is strongly bent, depending on the tidal phase. At the beginning of the time series the current is purely northward and we observe the lower plume from Red Lion not the Turtle Pits plume, because during the hours before the current had an eastward component, driving the Turtle Pits plume away from the observational site. Later on, as the currents get a westward component, the upper Turtle Pits plume appears while the lower Red Lion plume gets weaker.

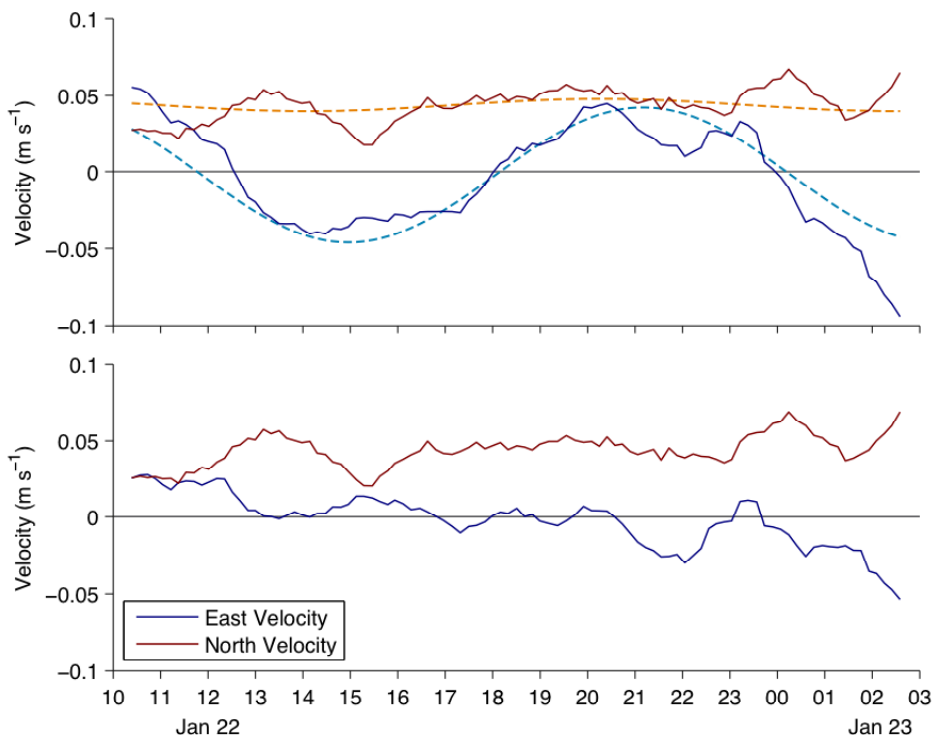

Fig. 2.4.1.5: Time series of the mean velocity in the plume layer between 2750 m and 3000 m measured on January 22/23 about 700 m north of the Red Lion vent field. The east velocity is shown in blue and north velocity in red. Harmonic fits of the semidiurnal M_2 tide are shown as dashed lines. The residual velocities after removal of the tides are shown in the lower panel

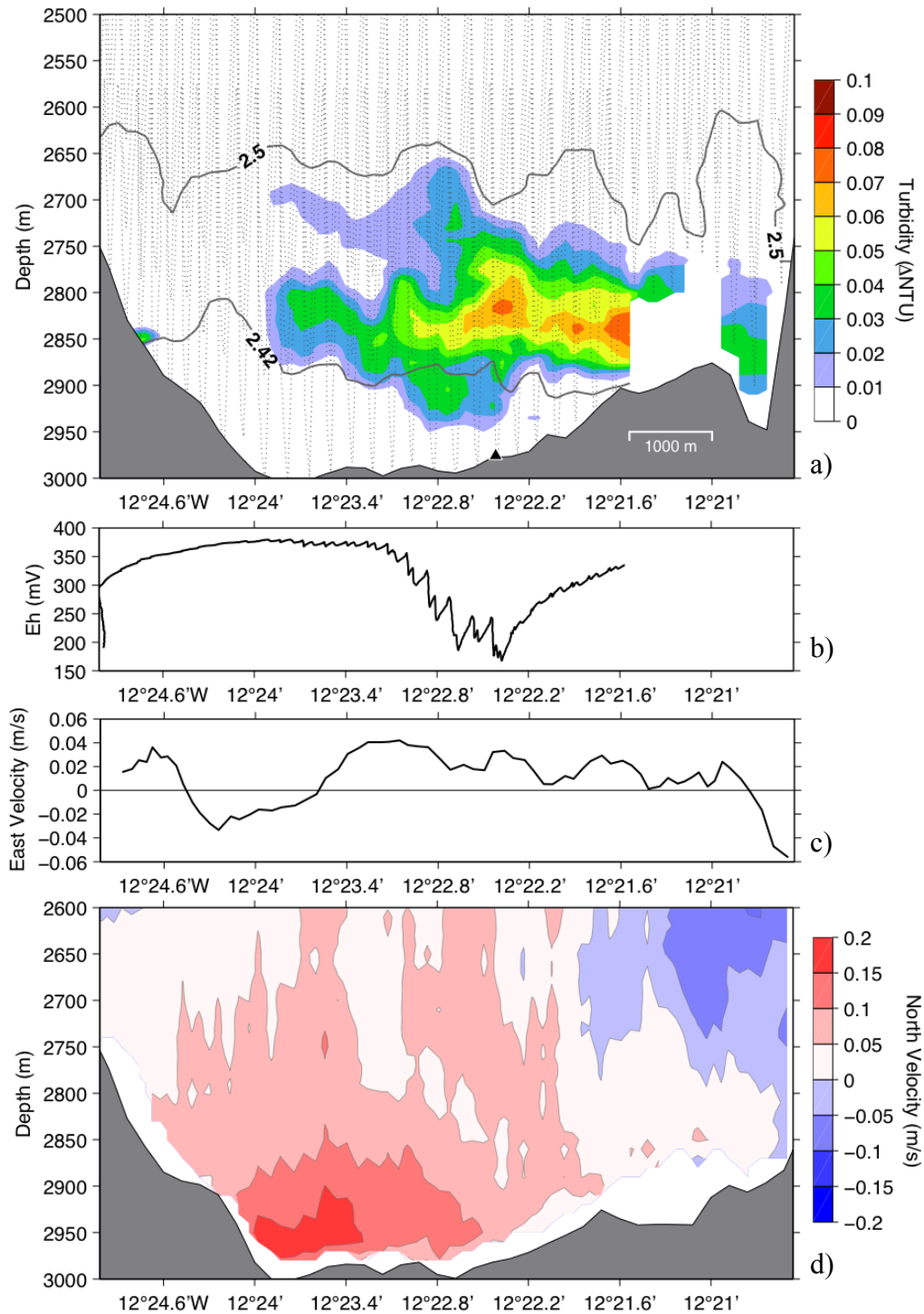

Fig. 2.4.1.6: Observations during a 5 nm long tow-yo crossing the rift valley from west to east. The CTD was navigated using POSIDONIA. (a) Turbidity from three MAPRs, one mounted on the CTD frame and two attached to the wire 100 m and 200 m above the CTD. (b) Eh from the MAPR parallel to the CTD. (c) Mean eastward current velocity below 2750 m from ADCP measurements. (d) Contours of northward velocity from ADCP measurements

The tidal phase of the currents is also of large importance to explain the structure of the particle plume that was observed during the cross-valley tow-yo. The plume appears to be extremely wide and covers about three fourth of the section (Fig. 2.4.1.6). Again we have a northward flow of about 5 cm/s and a fluctuating east-west component that is eastward at the beginning of the towyo, then westward for about two hours, and then mostly eastward for the

remaining part of the towyo. Thus we can assume that the plume is first pushed westward toward the ship for a few hours which explains the far west reaching plume. Afterwards the plume moves eastward and more or less follows the ship and instrument package.

The current measurements during the towyo show that the area was dominated by along-valley northward currents. The average current velocity is typically of about 5 cm/s, with maxima of more than 15 cm/s. The strongest currents were observed close to the bottom where the overflow across the sill takes place. The volume transport associated with the flow observed during the towyo amounts to 0.12 Sv (1 Sv = 10^6 m³/s). For a more general determination of the background flow field that takes long term variability into account and for the precise determination of tidal amplitudes and phases, a moored profiler that measures CTD and velocity data in the lower 700 m was deployed at the sill of the valley, in the center of the vent fields at 12° 22.51' S, 4° 48.20' S.

2.4.2 Microbiology from low-temperature, diffuse and hot hydrothermal fluids

(Mirjam Perner, Nadine Markus)

The main objective of the microbiology group during this cruise was to collect low-temperature, diffuse and hot hydrothermal fluids from hydrothermal fields on the southern Mid-Atlantic Ridge to investigate:

1. the intra-field and inter-field microbial variability
2. the functioning of the microbial community, specifically focusing on microbial H₂- and H₂S-oxidation and CO₂ fixation.

Intra-field and inter-field microbial variability

To investigate the intra-field and inter-field microbial variability the following fluids were collected (see table 2.4.2.2):

3 hot hydrothermal fluids (Sisters Peak, Mephisto, Two Boats)

5 low-temperature diffuse fluids (Wideawake and Clueless, mussel patches)

To identify and quantify the local microorganisms in the fluids of different sites material was collected to construct clone libraries using the 16S rRNA gene and perform fluorescence *in situ* hybridization in the home laboratory.

Functioning of the microbial community

The functioning of the vent microbial community is studied by two approaches. The first includes cultivation of selected groups of bacteria and archaea. The second involves analysis of functional genes and parallel-performed ¹⁴C-incubation experiments with the decrease of potential electron-donors and acceptors being monitored.

Cultivation experiments

To characterize at least parts of the microbial community cultivations have been started on board (and will be continued in the home laboratory) specifically selecting for H₂-oxidizing and CO₂ fixing microorganisms (e.g. *Epsilonproteobacteria*, *Aquificales*, and

Methanococcales). For this purpose, selective media for autotrophic microorganisms was supplemented with various electron donors (H_2 , H_2S , S° , S_2O_3) as well as suitable electron acceptors (O_2 , NO_3 , S° , S_2O_3) in the presence of CO_2 .

Additionally, media for aerobic and anaerobic heterotrophic microorganisms was used. Cultivations were conducted along a temperature gradient of 25-75°C.

For the cultivation experiments, material was gathered from:

- 1 hot hydrothermal fluid (Sisters Peak, Comfortless Cove)
- 3 low-temperature diffuse fluids (Wideawake and Clueless mussel patches)

¹⁴C-incorporation experiments

The second approach investigates the functioning of the vent microbial community by using functional genes encoding for key enzymes of H_2 -oxidation, oxidation of reduced sulfur compounds and CO_2 fixation. However, the presence of functional genes encoding key enzymes of specific metabolisms is no proof of the actual functioning of this metabolism. Therefore, additionally, ¹⁴C-incorporation experiments (at 25°C) were performed with hydrothermal fluids, which were supplemented with H_2 (under oxic and anoxic conditions) or H_2S as electron donor. The decrease of the supplied electron donors (H_2 or H_2S) and electron acceptors (O_2) was monitored during the 30 hours of incubation.

For this experiment hydrothermal fluids were collected from 3 diffuse fluids (Wideawake, Clueless) and 1 hot fluid from Mephisto (Red Lion)

Four parallels with each 15 ml of the hydrothermal fluids were supplemented with

- H_2 -gas under anoxic conditions
- H_2 -gas under oxic conditions
- H_2S
- nothing (reference)

and injected with $^{14}CO_3^{2-}$. Three parallel controls using liquids that were microorganism-free (filtered through a 0.1 μm filter) and liquids with non-active microorganisms (sample was fixed with formaldehyde) were incubated to determine the non-biological loss of H_2 , O_2 and H_2S in the incubation bottles. These values were taken into consideration when evaluating the decrease of H_2 , O_2 and H_2S in the incubation experiment.

H_2 , O_2 and H_2S contents were monitored at time points 0 and after 30 hours of incubation (Fig. 2.4.2.1). The amount of labeled inorganic carbon, which has been incorporated into the cells, has been measured for one of the parallels on board (Fig. 2.4.2.1) and will be determined for the other three parallels in the home laboratory.

substrate decrease and inorganic carbon fixation in hydrothermal fluids
during ^{14}C incubation under distinct chemical conditions

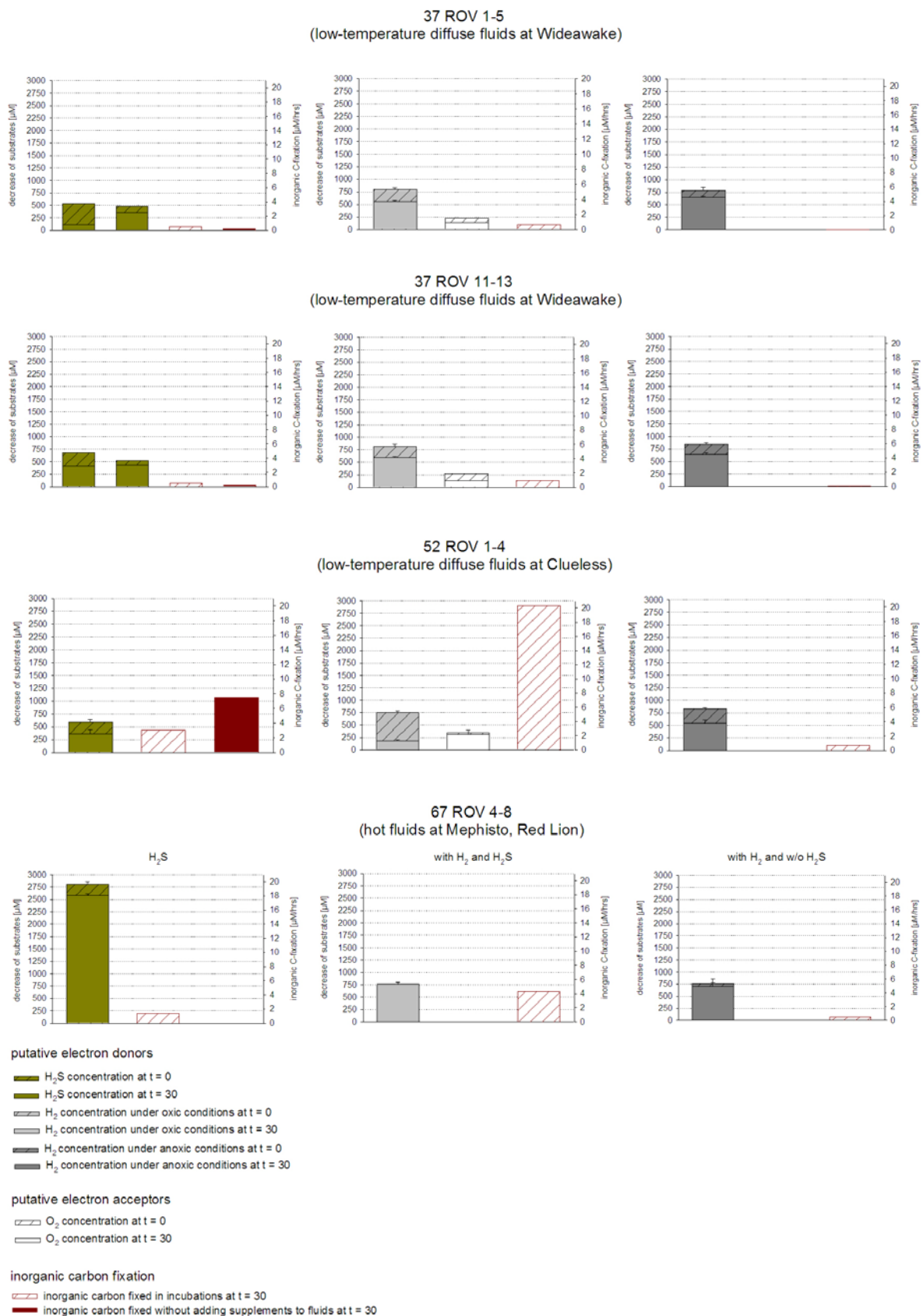

Fig. 2.4.2.1: The decrease of substrates (H_2 , H_2S and O_2) under distinct conditions is shown for a 30 hour time-period in the incubation experiments at 25°C . H_2 data by Marko Warmuth and Richard Seifert (University Hamburg); H_2S data by Harald Strauss (University Münster). Fluids at Mephisto were anoxic therefore no O_2 decrease could be determined.

Table 2.4.2.1: Sample list of CTDs

station	depth [m]	niskin bottle number	DNA (-70°C)	FISH (fixed in formaldehyde)
ATA02-31CTD = ATA02-CTD01	3000	1-6	filter 2-2 (900 mL)	filter 3000 (100mL)
	2700	13	filter 2-3 (900 mL)	filter 2700 (100mL)
	2600	14	filter 2-1 (900 mL)	filter 2600 (100 mL)
	2200	17	filter 2-7 (450 mL)	filter 2200 (45 mL)
	1800	19	filter 2-5 (450 mL)	filter 1800 (45 mL)
	100	20	filter 2-4 (900 mL)	filter 100 (100mL)

Table 2.4.2.2: Sample list of hydrothermal fluids taken with the KIPS during the ROV dives

station	site	KIPS bottle number	DNA (-70°C)	FISH (fixed in formaldehyde)	culture name	target organism	CO ₂ rates t (°C)
Rocks Turtle Pits 35 ROV							
ATA02-35 ROV 16	Turtle Pits		rock	rock			
ATA02-35 ROV 16A	Turtle Pits		rock	rock			
Diffuse fluids Wideawake (4 bottles taken) 37 ROV 1-5 11:50-12:18 UTC							
ATA02-37 ROV 1-5	Wideawake	C8/B6/B5	filter 2-8 (200 mL) filter 2-9 (400 mL) filter 2-10 (200 mL)	filter (200 mL)			
					38	Desulfurobacterium group,	25
					39	Desulfurococcales &	55
					40	Epsilonproteobacteria	75
					41	Thermales + Aeropyrum	55
					42	Thermales + Aeropyrum	75
					43	Methanococcales	37
					44	Methanococcales	55
					45	Methanococcales	75
					46	Thermococcales	75
					47	Aquificales + Epsilonproteobacteria	25
					48	Aquificales + Epsilonproteobacteria	37
					49	Aquificales + Epsilonproteobacteria	55
					50	Aquificales + Epsilonproteobacteria	75
					51	Archaeoglobales	55
					52	Archaeoglobales	75
							1H2.0-1
							1H2.0-2
							1H2.0-3
							1H2.0-4
							1H2.A-1
							1H2.A-2
							1H2.A-3
							1H2.A-4
							1H2S-1
							1H2S-2
							1H2S-3
							1H2S-4
							1Ref1
							1Ref2
							1Ref3
							1Ref4

station	site	KIPS bottle number	DNA (-70°C)	FISH (fixed in formaldehyde)	name	culture target organism	t (°C)	CO ₂ rates
Diffuse fluids Wideawake (5 bottles taken) 37 ROV 10-13 15:58-16:18 UTC					55	Desulfurobacterium group,	25	2H2.0-1
ATA02-37 ROV 11-13	Wideawake	A2/A3	filter 2- 11 (500 mL)	filter (200 mL)	56	Desulfurococcales &	55	2H2.0-2
					57	Epsilonproteobacteria	75	2H2.0-3
					53	Thermates + Aeropyrum	55	2H2.0-4
					54	Thermates + Aeropyrum	75	2H2.A-1
					58	Methanococcales	37	2H2.A-2
					59	Methanococcales	55	2H2.A-3
					60	Methanococcales	75	2H2.A-4
					61	Thermococcales	75	2H2S-1
					62	Aquificales + Epsilonproteobacteria	25	2H2S-2
					63	Aquificales + Epsilonproteobacteria	37	2H2S-3
					64	Aquificales + Epsilonproteobacteria	55	2H2S-4
					65	Aquificales + Epsilonproteobacteria	75	2Ref1
					66	Archaeoglobales	55	2Ref2
					67	Archaeoglobales	75	2Ref3 2Ref4
Hot fluids ATA02-42 ROV 12 (Sisters Peak, Comfortless Cove) 16:54-16:58 UTC					68	Desulfurobacterium group	75	
ATA02-42 ROV 12			filter 2-12 (100 mL)	filter (10 mL)	69	Methanococcales	75	
			filter 2-13 (100 mL)	filter (40 mL)	70	Thermococcales	75	
			filter 2-14 (100 mL)		71	Aquificales + Epsilonproteobacteria	75	
					72	Archaeoglobales	75	

station	site	KIPS bottle number	DNA (-70°C)	FISH (fixed in formaldehyde)	culture name	CO ₂ rates t (°C)
Rocks ATA02- 46 ROV (Wideawake slurp gun)			rock			
Diffuse fluids Clueless (4 bottles taken) 52 ROV 1-4 13:59-14:17 UTC						
ATA02-52 ROV 1,2, 4	Clueless	C9/C8/B6	filter 2-21 (100 mL)		73 Desulfurobacterium group,	37 3H2.0-1
			filter 2-22 (100 mL)		74 Desulfurococcales &	55 3H2.0-2
			filter 2-23 (100 mL)		75 Epsilonproteobacteria	75 3H2.0-3
			filter 2-24 (100 mL)		76 Methanococcales	37 3H2.0-4
					77 Methanococcales	55 3H2.A-1
					78 Methanococcales	75 3H2.A-2
					79 Thermococcales	37 3H2.A-3
					80 Thermococcales	55 3H2.A-4
					81 Thermococcales	75 3H2S-1
					82 Aquificales + Epsilonproteobacteria	37 3H2S-2
					83 Aquificales + Epsilonproteobacteria	55 3H2S-3
					84 Aquificales + Epsilonproteobacteria	75 3H2S-4
					85 Archaeoglobales	37 3Ref1
					86 Archaeoglobales	55 3Ref2
					87 Archaeoglobales	75 3Ref3 3Ref4
ATA02-52 ROV 5,6,7	Clueless	B4/B5/A3	filter 2-20 (400 mL)			
ATA02-52 ROV 8,9	Clueless	A2/A1	filter 2-15 (150 mL)			
			filter 2-16 (55 mL)			
			filter 2-17 (55 mL)			
			filter 2-18 (55 mL)			
			filter 2-19 (55 mL)			
Hot fluids 57 ROV 2 (Turtle Pits) (4 bottles) 15:35-15:39 UTC						
ATA02-57 ROV 2	Turtle Pits		filter 2-25 (3 x 66 mL)	filter (1 mL)		
			filter 2-26 (3 x 66 mL)			
				filter (45 mL)		

station	site	KIPS bottle number	DNA (-70°C)	FISH (fixed in formaldehyde)	culture name	CO ₂ rates t (°C)
Hot fluids Mephisto (Red Lion) (5 bottles taken) 67 ROV 4-8 14:48-15:03 UTC						
ATA02-67 ROV 4-8	Mephisto	C9/C8/B6	filter 2-27 (50 ml) filter 2-28 (50 ml)	filter (1 mL) filter (45 mL)		4H2.0-1 4H2.0-2 4H2.0-3 4H2.0-4 4H2.A-1 4H2.A-2 4H2.A-3 4H2.A-4 4H2S-1 4H2S-2 4H2S-3 4H2S-4 4Ref1 4Ref2 4Ref3 4Ref4

2.4.3 Temperature measurements of low-temperature, diffuse hydrothermal fluids

(Mirjam Perner, Dieter Garbe-Schönberg)

During the sampling of the low-temperature hydrothermal fluids with the KIPS at Wideawake and Clueless the temperature was monitored (Fig. 2.4.3.1 A-C).

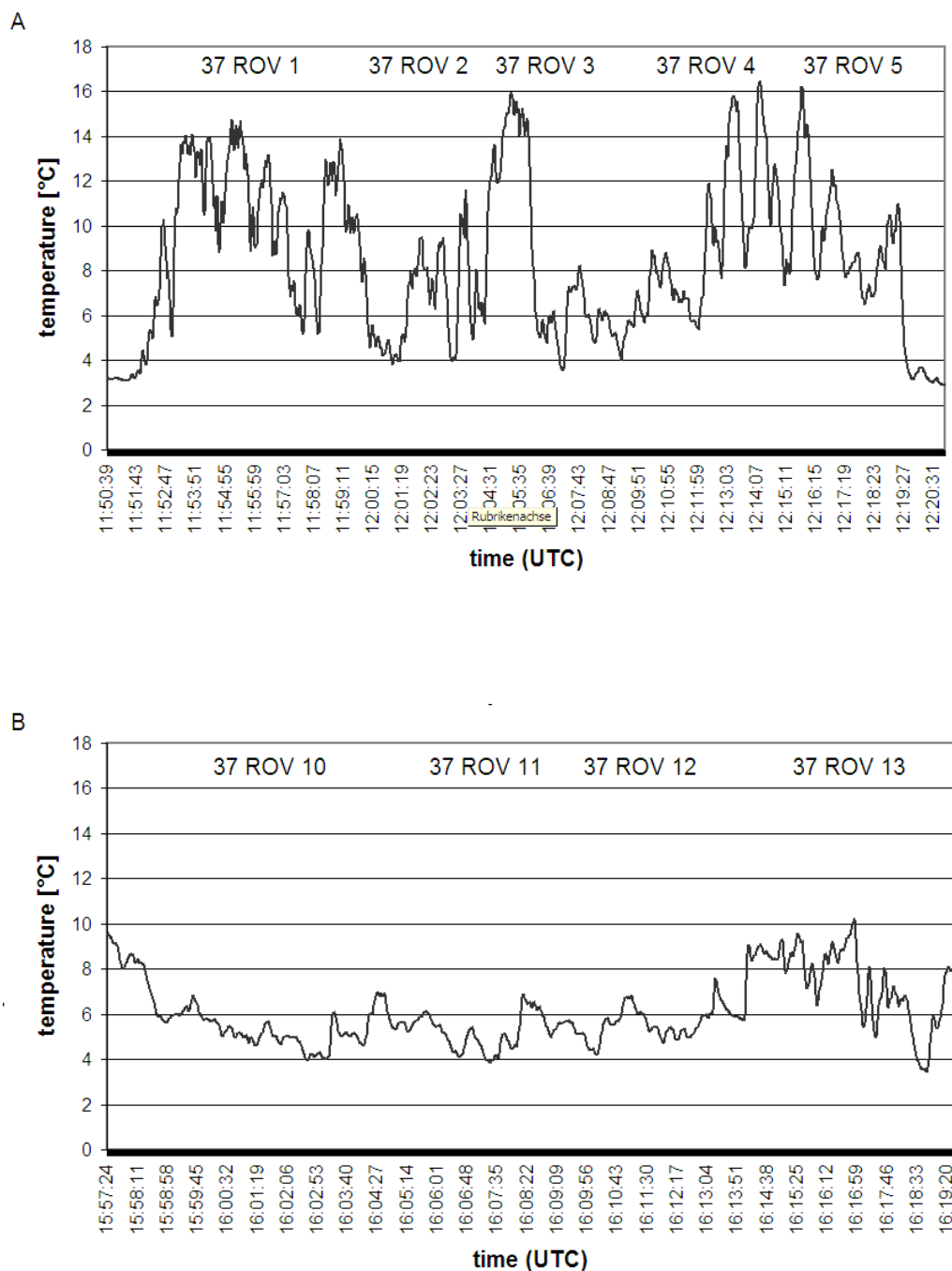

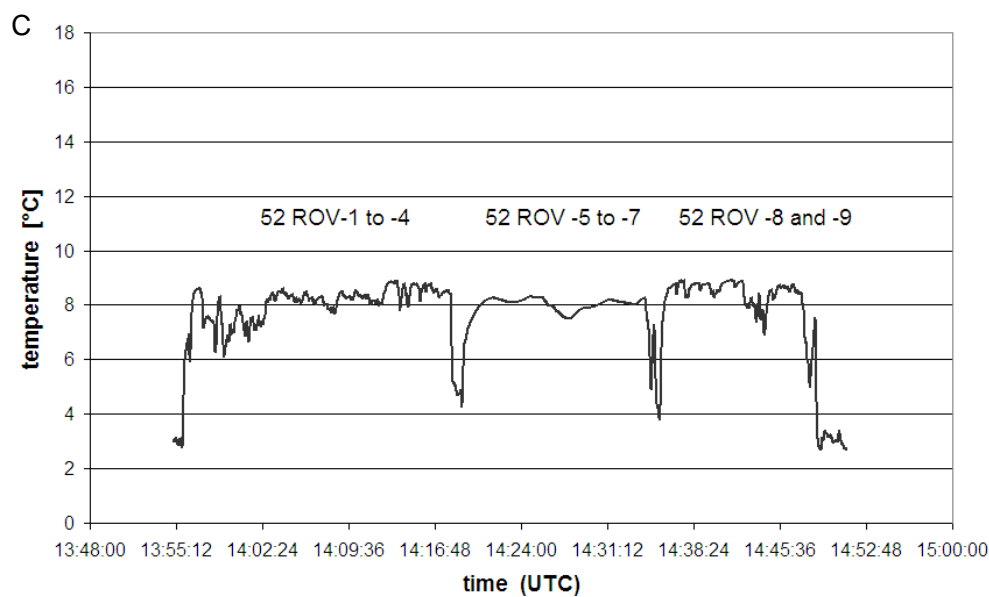

Fig. 2.4.3.1: Temperature measured during sampling of low-temperature diffuse fluids at Wideawake (A, B) and at Clueless (C).

Following the fluid sampling the 8-channel temperature logger was inserted into the spot of sampling and measured temperatures along a vertical gradient for 20-30 minutes (Figs. 2.4.3.3, 2.4.3.5, 2.4.3.7).



Fig. 2.4.3.2: Measurement of temperature with the 8-channel temperature logger at the low-temperature diffuse outlet at Wideawake (37 ROV6).

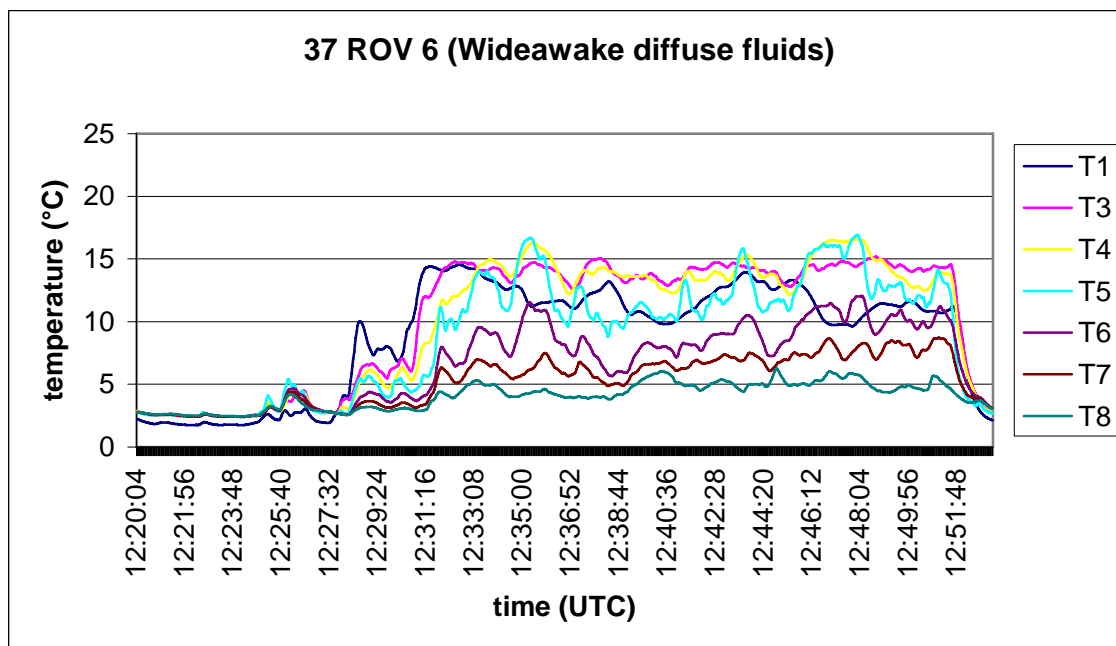

Fig. 2.4.3.3: Measurement of temperature with the 8-channel temperature logger at the low-temperature diffuse outlet at Wideawake (37 ROV6). T1 = 28 cm depth, T3 = 24 cm, T4 = 20 cm, T5 = 16 cm, T6 = 12 cm and T7 = 8 cm.



Fig. 2.4.3.4: Measurement of temperature with the 8-channel temperature logger at the low-temperature diffuse outlet at Wideawake (37 ROV13).

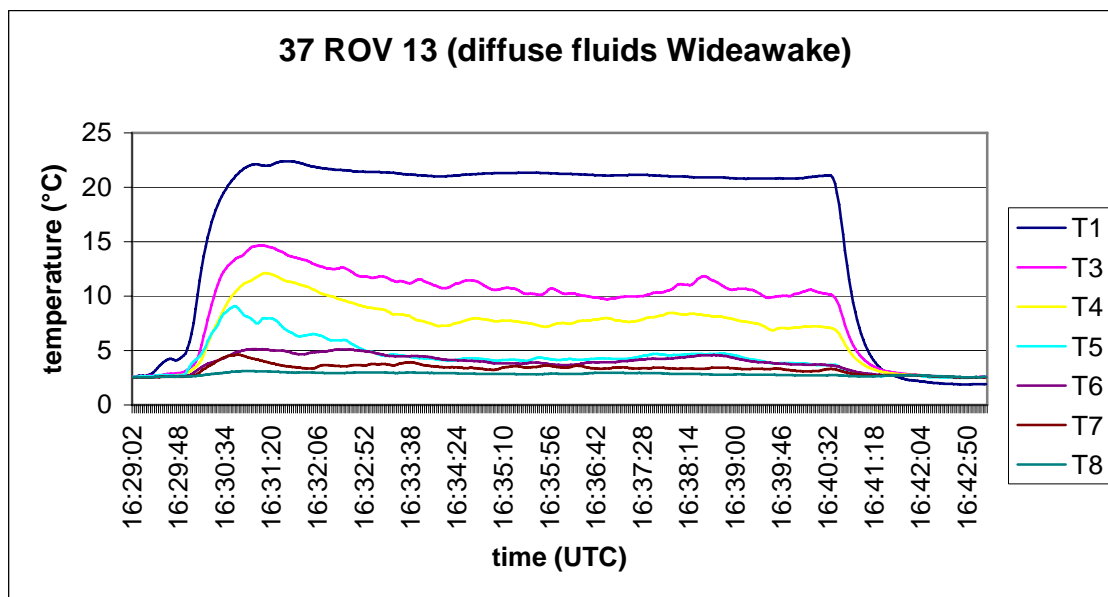

Fig. 2.4.3.5: Measurement of temperature with the 8-channel temperature logger at the low-temperature diffuse outlet at Wideawake (37 ROV13). T1 = 28 cm depth, T3 = 24 cm, T4 = 20 cm, T5 = 16 cm, T6 = 12 cm and T7 = 8 cm.

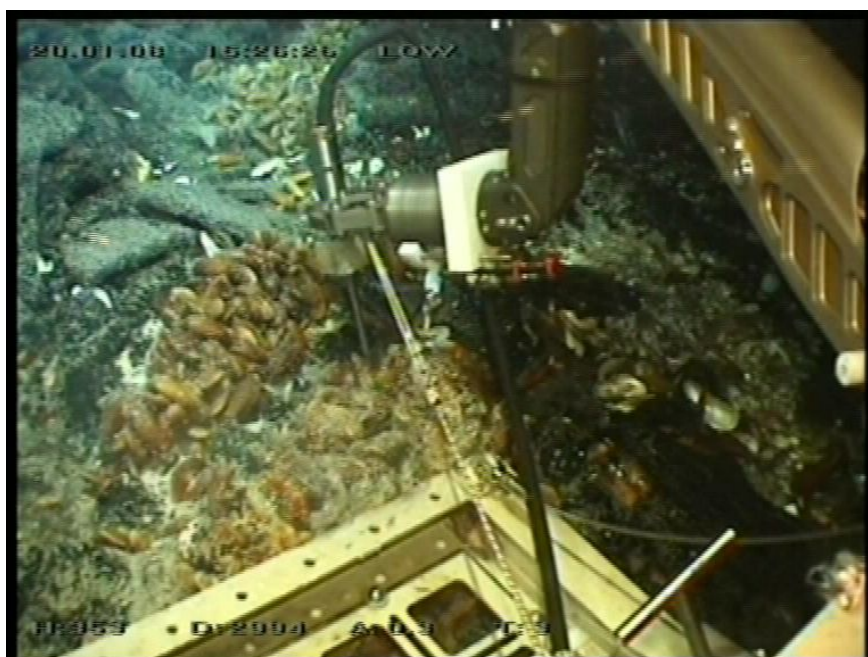

Fig. 2.4.3.6: Measurement of temperature with the 8-channel temperature logger at the low-temperature diffuse outlet at Clueless (52 ROV10).

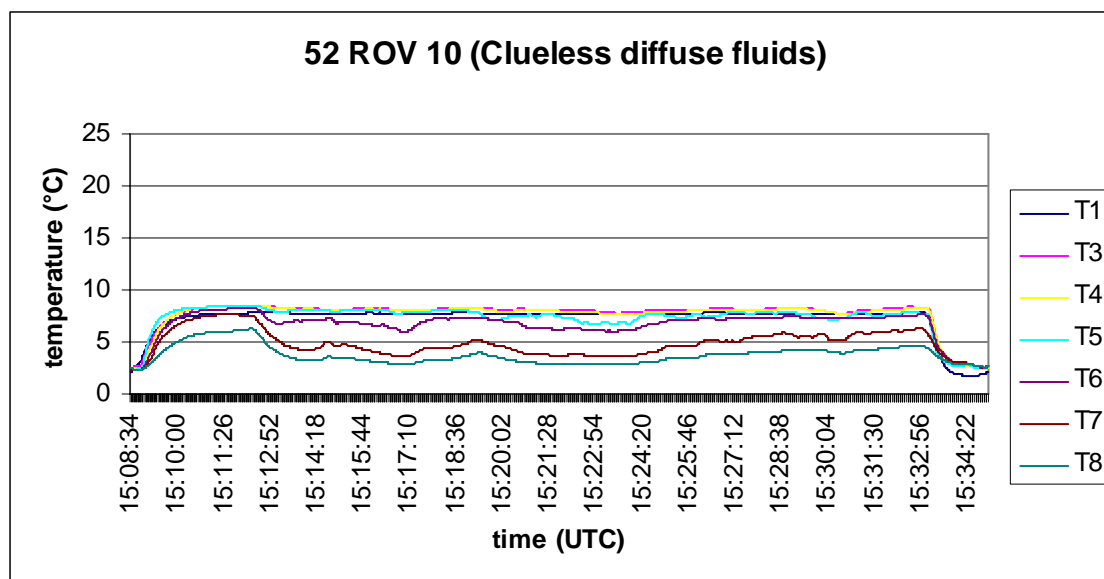

Fig. 2.4.3.7: Measurement of temperature with the 8-channel temperature logger at the low-temperature diffuse outlet at Clueless (52 ROV10). T1 = 28 cm depth, T3 = 24 cm, T4 = 20 cm, T5 = 16 cm, T6 = 12 cm and T7 = 8 cm.

2.4.4 Fluid chemistry

(Dieter Garbe-Schönberg, Katja Schmidt, Harald Strauss, Verena Klevenz, and Phillip Hach)

2.4.4.1 Fluid sampling

Kiel Pumping System (KIPS)

One pre-requisite for an accurate estimate of the composition of hydrothermal fluids venting at high-temperature Black Smokers or from diffuse mussel-field sites is sampling of the hydrothermal fluids without entrainment of ambient seawater which would cause immediate precipitation of sulphides and barite and, hence, loss of these compounds from solution. One measure of the purity of the sampled hydrothermal fluid is temperature. Consequently, real-time *in-situ* measurement of the temperature helps to guide the tip of the sampling nozzle to the hottest region within the vent orifice where the purity of the venting fluid is highest and least diluted with seawater. Another pre-requisite is that all materials coming into contact with the sampled fluid are inert and have lowest adsorption coefficients preventing systematic errors introduced by either contamination or losses due to adsorption. Precipitation during cooling of the sampled fluid, however, cannot completely be avoided.

A remotely controlled flow-through system – the Kiel Pumping System (KIPS-3) - mounted on the ROV's starboard tool sled was used for this purpose (Garbe-Schönberg et al., 2006). The parts of the system getting into contact with the sample are entirely made of inert materials and are stable up to temperatures of 260 °C (short-term 305 °C): perfluoralkoxy (PFA), polyetherethyleneketone (PEEK), polytetrafluorethylene (PTFE, Teflon®), and a short tube of high-purity titanium (99.9 % Ti). Fluid enters via this titanium tube (40 cm length, 6 mm I.D., bent to 90°) - the nozzle - mounted to a T-handle which is guided by the

ROV's ORION manipulator arm (Fig 2.4.4.1). Parallel to the titanium nozzle is a high-temperature sensor (see below) delivering real-time temperature data for the tip of the nozzle. Coiled PFA tubing (3/8" O.D., 3 m length) connects the nozzle to a remotely controlled multi-port valve (PEEK/ PTFE) delivering the fluid to the respective sampling flask. The valve is driven by a stepper motor (electric actuator, Schilling Robotics, U.S.A.) and controlled from a separate laptop via RS232 tunneling through the ROV control system (Kiel 6000 ROV: Node 6, port #14). The software package used was FluidCtrl V. 3.0.0 by Jens Renken @ Marum Soft, Bremen.

The multiport valve has 9 ports connected to 9 single PFA flasks with 675 ml volume each (Nalgene, USA). Each bottle is equipped with a check valve at the outlet. The flasks are mounted in three racks A-C, with every rack containing three horizontally positioned bottles (A1-A3, B4-B6, C7-C9), allowing an easy transfer of the racks to the laboratory where sub-sampling was done. Flasks were pre-filled with ambient bottom seawater (North Atlantic Deep Water, NADW) obtained from previous CTD hydrocasts. A 24 V deep sea mechanical gear-pump is mounted downstream to the sample flasks, thus avoiding contamination of the samples. The pumping rate was approx. 1 L/min at 24 VDC. The standard pumping time per sample was set to 4 min. making sure that the flask volume was exchanged at least 5 times. The outlet of the KIPS system is located on the porch at the front-side of the ROV, where video control allows the observation of warm shimmering fluids leaving the system. In addition, a flow mobile was attached to the outlet tube at diffuse vent sites.

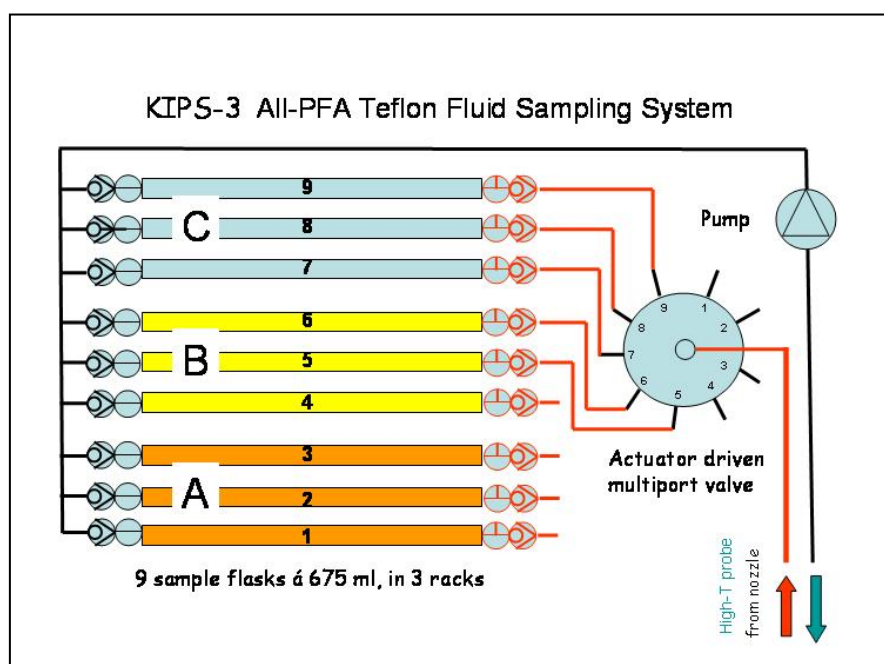

Fig. 2.4.4.1: Schematic configuration of the inert KIPS fluid sampling system (only tubing connections to flasks # 5 - # 9 are shown for clarity). Fluid entering the nozzle is distributed by a motorized multiport-valve to 9 PFA sample flasks á 675 ml, each with check valves and stopcocks. The pump is positioned downstream. Racks A, B, C with 3 flasks each can be quickly removed and sub-sampled in the lab.

A high-precision thermistor temperature sensor (manufactured by H.-H. Gennerich, Bremen) inside a stainless steel pressure housing was attached parallel to the nozzle. The 90% time constant of the sensor in water was better than 10 s. The sensor is connected to a RBR logger TR-1050R (Serial# 12644, RBR Brancker, Canada) for real time data conversion to

calibrated temperatures and data storage. A Y-splice cable connection accomplished real time data transfer through the ROV's RS232 data line and the display on a ROV control van monitor. Two individual sensors were used during this cruise: temperature probe #5 during stations ATA 35 ROV through ATA 42 ROV, and T probe #4 for all subsequent dives. Calibration coefficients used during the cruise are tabulated in Table 2.4.4.1. Prior to the cruise a 23-points high-precision calibration covering 0-450 °C was performed at an ISO-certified calibration lab (TESTO, Germany) for each of the sensors.

Table 2.4.4.1: Calibration coefficients for resistance data-to-temperature conversion of T probes #5 and #4 at RBR logger TR-1050.

T probe #5 (NTC No 193729)		T probe #4 (NTC No 193731)	
A0	0.003516129399127	A0	0.00347114037326
A1	-0.000256163403706	A1	-0.000255203453916
A2	0.000002731961606	A2	0.000002719519579
A3	-0.000000081982648	A3	-0.000000080192994

Major water samplers

In addition to the KIPS, we used two titanium syringes ("Major" after von Damm et al., 1985; manufactured by IFREMER/ BREST-MECA) to collect hot hydrothermal fluids at Turtle Pits, Comfortless Cove and Red Lion. The total sample volume for one major is 750 ml (Fig 2.4.4.2). The samplers were constructed primarily of titanium with seals made of teflon and viton. The syringes are not gas-tight: a simple lab test showed that bubbling from the samplers started at 1.5 bars overpressure. They are constructed to be self-flushing and are sent to the seafloor in chocked mode. To take a fluid sample, the snorkel is placed into the vent orifice. First, only the snorkel gets flushed by the fluid; a control for a good position in the undiluted part of the fluid outflow is allowed by observing the small flushing outlet opening. Undiluted hydrothermal fluid without seawater mixing is indicated by a clear solution leaving the outlet. Triggering the sampler is accomplished by pushing the releaser with a hydraulic cylinder mounted on the ROV manipulator arm. This releaser 1) closes the flushing valve, 2) opens the valve to the sample chamber, and 3) releases the pin holding the piston rod so that the large spring can pull the piston back soaking hydrothermal fluid into the sample chamber. To recover the sample on board tubing is connected to the small outlet valve of the sample chamber. For gas sampling, vacuum extraction was applied (see section on Dissolved Gas Chemistry). Thin black coatings in the sample chamber were observed in most cases, caused by precipitation of sulfides.

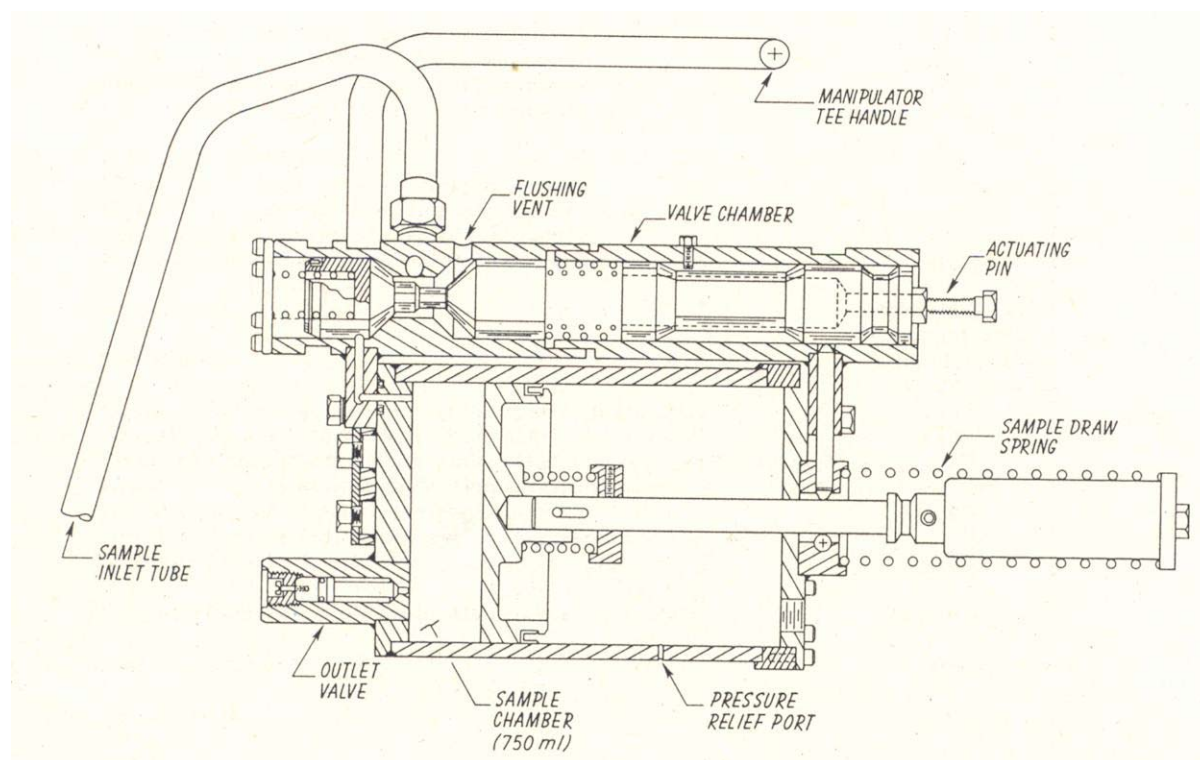

Fig. 2.4.4.2: Schematic drawing of “Major” titanium syringe sampler after von Damm, 1985 (*Geochimica et Cosmochimica Acta* 49, 2197–2220).

In total, 22 hot fluid samples were collected utilizing KIPS and Majors: seven from Turtle Pits (Two Boats), nine from Comfortless Cove (Sisters Peak) and six from Red Lion (Mephisto). Diffuse fluids were collected at two different locations at Wideawake (9 samples) and Comfortless Cove (Golden Valley – 9 samples).

Buoyant hydrothermal plumes were sampled by means of the CTD/Rosette, equipped with 24 bottles à 10 l volume and operated as tow-yos (see section oceanography for details). In total, 16 water column profiles were sampled and immediately acidified in order to determine Fe and Mn in these samples.

Sub-sampling and sample preparation for on-board analyses and subsequent measurements in the home laboratories

Immediately after recovery of the ROV on deck KIPS sample racks and Ti majors were transferred to the laboratory for subsampling following a standardized protocol (see appendix). In addition to the onboard analyses, further fluid sample aliquotes were taken for measuring fluid chemical composition and selected isotopes.

In order to fulfill the requirement for trace metal analyses to work on identical sample aliquots, the rest of each sample was first transferred to one PFA bottle, homogenized by shaking and further distributed to the respective bottles. Furthermore, hot hydrothermal fluids emanating from black smokers contain precipitates formed during cooling and mixing with seawater. On board, aliquots were not filtered but acidified with 1-5 ml subboiled HNO₃ per 100 ml fluid and stored in PFA bottles. A second set of aliquots were pressure filtrated (99.9990 nitrogen) through 0.2 µm Nuclepore PC membrane filters in a Sartorius filtration unit, acidified with 0.2 ml subboiled concentrated nitric acid per 100 ml and also stored in

100 ml PFA bottles until analyses. Procedural blanks were processed in regular intervals. All work was done in a class 100 clean bench (Slee, Germany) using all-plastic labware (HDPE, PC, FEP, PFA). Rinse water was ultrapure (>18.2 MOhm) dispensed from a Millipore Milli-Q system.

After return to the home labs in Kiel and Bremen samples will be analysed for major and minor elemental composition (Na, K, Ca, Mg, Sr, Ba, B, Fe, Mn, Cu, Zn) by means of ICP-optical emission spectrometry (Ciros SOP; Spectro) and trace elements (e.g., I, Br, B, Li, Al, Ti, Cs, Ba, Sr, Y-REE, Fe, Mn, Cr, V, Cu, Co, Ni, Pb, U, Mo, As, Sb, W) by ICP-mass spectrometry using both collision-cell quadrupole (U-Kiel: 7500 cs, Agilent, JU-Bremen: Elan DRC-e, Perkin Elmer) and high resolution sector-field instrumentation (U-Kiel: PlasmaTrace 2, Micromass). At JUB in Bremen, complementary analyses on the speciation of metals will be carried out using voltammetry (computrace VA 757, Metrohm). For anion analyses (e.g., Cl^- , Br^- , I^- , SO_4^{2-}), aliquots of hot hydrothermal fluids with precipitate were pressure-filtrated through $0.2\ \mu\text{m}$ PC membrane filters (Nuclepore). For amino acids and other organic compounds, respective measurements will be carried out in collaboration with Dr. Ostertag-Henning at Bundesanstalt für Geowissenschaften und Rohstoffe (BGR, Hannover, Germany). Onboard, non-filtered sub-samples for organic analyses were immediately frozen (-20°C) as 50 ml aliquots in glas bottles. Filters from filtration of the KIPS fluid samples of the ROV were kept in plastic containers. Samples for the detection of dissolved inorganic silica were diluted 1:50 from the concentrated fluid (filtered and acidified) with DI water.

Further subsamples were collected for stable isotope analyses. Filtered aliquotes of hot hydrothermal fluids (2x2 ml) were stored with no headspace in crimp-sealed glass vials for hydrogen ($\delta^2\text{H}$) and oxygen isotope measurements ($\delta^{18}\text{O}$). Hydrogen sulfide dissolved in the hydrothermal fluids was precipitated as zinc sulfide with a 3% zinc-acetate solution, filtered and dried for measuring the four stable sulfur isotopes (^{32}S , ^{33}S , ^{34}S , ^{36}S). For determining the carbon isotopic composition of inorganic carbon ($\delta^{13}\text{C}$) dissolved in hot and diffuse hydrothermal fluids, 20 ml aliquotes were poisoned with two drops of HgCl_2 and stored in the dark. Stable isotope measurements will be carried out at the Geologisch-Paläontologisches Institut, Universität Münster, Germany. For Ca, Sr, and Cl isotope measurements, 50 ml of non-filtered hydrothermal fluid were stored in HDPE bottles.

2.4.4.2 Analytical procedures on-board

In general, on-board measurements were performed immediately after sample recovery on deck. Sampling followed a standardized protocol in order to avoid oxidation of highly redox-sensitive dissolved constituents in the hydrothermal fluids.

pH and Eh

Non-filtered aliquots of each sample were subjected to immediate pH and Eh measurements (Ag/AgCl reference electrode).

Dissolved oxygen

Dissolved oxygen was determined for diffuse hydrothermal fluids following the classical Winkler method as outlined in Grasshoff (1999). The method was slightly modified in order to utilize 10 ml volumetric flasks. The detection limit is approx. $0.5\ \text{ml/l O}_2$, precision is in the range of $\pm 0.1\ \text{ml/l O}_2$. The samples were analysed by Mirjam Perner and Nadine Markus (see section on Microbiological Diversity).

Iron speciation

Determination of iron speciation was performed spectrophotometrically. The method is based on determining the orange-red ferrioxal complex, which is formed by Fe(II) ions in the fluid sample complexed with 1% (w/v) 1,10-phenantroline in a pH range of 3-5. In addition to the quantification of Fe(II), the total Fe content is measured by reducing all Fe with a 1% (w/v) ascorbic acid solution. Fe(III) concentration is calculated as the difference between total Fe and Fe(II). Analyses were carried out with a Biochrom Libra S12 spectrophotometer at a wavelength of 511 nm.

Dissolved sulfide

For onboard analysis of dissolved sulfide concentrations, initially two different methods were applied: voltammetry and spectrophotometry.

All voltammetric measurements were performed on a 757 VA Computrace with a standard PC (Metrohm, Herisau, Switzerland). The three-electrode configuration consisted of the static mercury drop electrode (SMDE) as the working electrode, an Ag/AgCl reference electrode (3M KCl), and a platinum wire as the auxiliary electrode. Sulfide concentrations were determined by using a NaOH 0.1M oxygen-free solution (Application Bulletin No. 199/3, Metrohm, Herisau, Switzerland).

Spectrophotometry of dissolved sulfide is based on the light absorption of methylene blue at a wave length of 660 nm. Dissolved sulfide is stabilized in a colloidal form as zinc sulfide using zinc acetate gelatine solution (100 µl for 1 ml of hydrothermal fluid). The sulfide reacts with N,N-dimethyl-1,4-phenylene-diamine-dihydrochloride to colourless leucomethylene and – through oxidation by Fe(III) supplied by an FeCl₃-solution – further to methylene blue. Photometric measurements were performed using a Biochrom Libra S12 spectrophotometer. Concentrations of the freshly prepared stock solution utilized for calibration were determined by titration with a 0,02N sodium-thiosulfate solution.

Further measurements of sulfur speciation (i.e., intermediate sulfur species like sulfite or thiosulfate) will be performed at the home laboratory, following the monobromobimane method (Fahey and Newton, 1987). On board, 50µl volume of the hydrothermal fluid was added to 110µl of previously prepared derivatization mixture, composed as follows: 50µl of HEPES buffer, 50µl acetonitrile and 10µl monobromobimane (48mmol/L). Derivatization was performed in the dark and was stopped after 30 min by adding 100µl of methanesulfonic acid (Rethmeier et al., 1997). Several advantages derive from this approach: the opportunity to quantify additional metastable sulfur phases, to separate these for isotopic measurements (method currently being developed in cooperation with Dr. Ostertag-Henning, BGR Hannover), and to perform respective measurements on substantially smaller sample volumes.

Chloride

Phase separation in hydrothermal fluids is reflected in chlorinities substantially different from seawater. Accordingly, chloride concentrations were quantified by titration with 0.1M AgNO₃ using fluoresceine-sodium as indicator (after FAJANS). For reference, seawater was measured at 560 mM.

2.4.4.3 *First results****In situ*-temperatures and chemistry of Black Smoker hydrothermal fluids**

A dedicated high-precision thermistor-based temperature sensor integrated within the KIPS fluid sampling system and mounted parallel to the sampling nozzle was used for our temperature measurements of hydrothermal fluids. It has to be kept in mind that fluids emerging e.g., at the top of a 12 m tall chimney may have already cooled or mixed with seawater inside the chimney structure. Moreover, vigorous venting involves turbulent mixing of hydrothermal fluids with seawater leading to a highly chaotic temperature distribution within the orifice. It becomes evident that temperature measurements under these conditions and with a ROV difficult to hold in position within a few millimetre for some tens of seconds are only a rough estimate of the real temperature of the hydrothermal fluid. However, quite constant temperature readings could be obtained for some high-temperature vents including the Two Boats vent at Turtle Pits where we measured a stable temperature of 451 ± 1.6 °C and a maximum temperature of 529 °C. These are the highest temperatures ever obtained for a black smoker fluid on the seafloor. This suggests that the phase-separated hydrothermal system at Turtle Pits and Comfortless Cove ($T_{\max} = 429$ °C (529 °C)) might react above the critical curve of the NaCl-H₂O system. In contrast, non-phase-separated fluids emerging at the Mephisto vent in the Red Lion hydrothermal system - in only 1 km distance to Two Boats - have temperatures of 366 °C (Table 2.4.4.2). The following Figs. 2.4.4.3 through 2.4.4.9 illustrate the temperature conditions during our fluid sampling of the high-temperature black smoker chimneys.

Table 2.4.4.2: Measured temperatures of venting hydrothermal fluids

Area	Site	2006 T_{\max} (°C)	2008 Station	2008 T_{\max} (°C)	2008 T_{avg} (°C)	Fluid sample No.
Hot venting						
Turtle Pits	Two Boats-Top	409	35 ROV	429	416 ± 2.3	No sample
	Two Boats-Bottom		35 ROV	529	451 ± 1.6	35 ROV-7
	Two Boats-Bottom		46 ROV	412	./.	46 ROV-7
	Two Boats-Bottom		57 ROV	371	./.	57 ROV-2/ -5
Comfortless Cove	Sisters Peak	400	42 ROV	379	367 ± 4.9	42 ROV-2 /-7
Red Lion	Mephisto	346	67 ROV	366	364 ± 0.6	67 ROV-3/ -8
Diffuse venting						
Wideawake	Wideawake mussel field	19	37 ROV	16	8	37 ROV-1/ -5 37 ROV-10/ -13
Comfortless Cove	Golden Valley/ Clueless Site	4	52 ROV	9	9	52 ROV-1 /-9

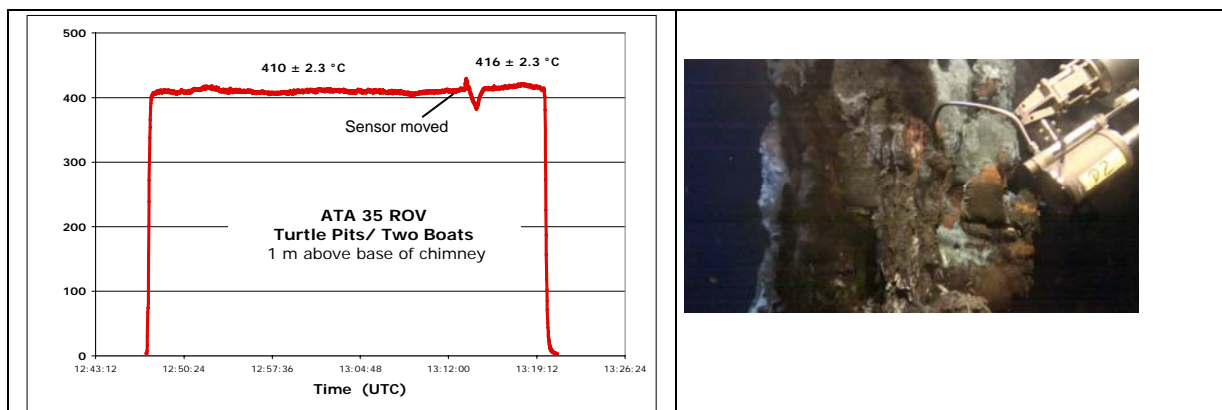

Fig. 2.4.4.3: Station ATA 35 ROV, Turtle Pits. Temperature readings and fluid sampling was at a small outlet approx. 1m above the base of Two Boats. Average over 20 minutes: 410 ± 2.3 °C. After the sensor had been repositioned temperature readings were 416 ± 2.3 °C over 5 minutes. The maximum temperature recorded was $T_{max} = 429$ °C. KIPS fluid sampling failed. Ti Major D2 filled, 35 ROV-7.

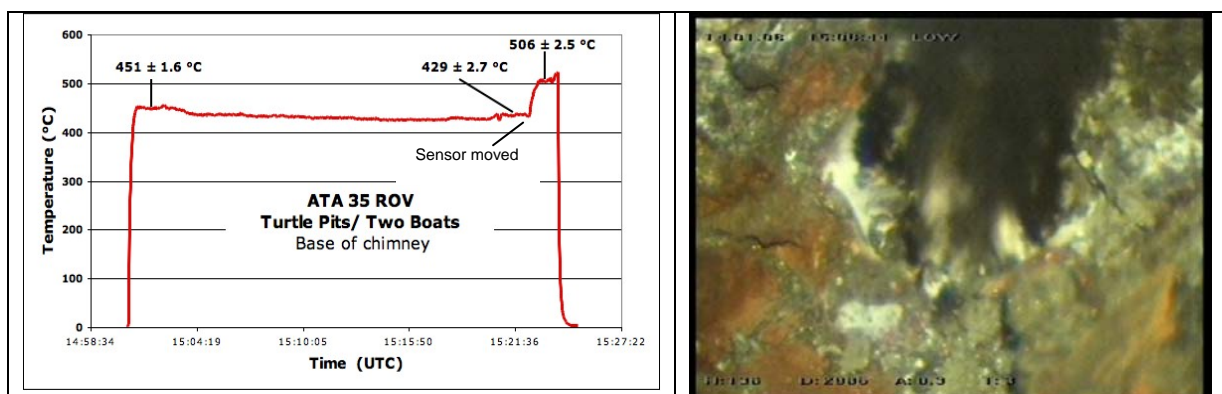

Fig. 2.4.4.4: Station ATA 35 ROV, Turtle Pits. Temperature readings were from a newly opened orifice at the base of the Two Boats black smoker. Initially, temperature was at 451 ± 1.6 °C but faded to 428 °C. Repositioning of the nozzle resulted in temperatures of 429 ± 2.7 °C. After fluid sampling was finished an attempt was made to relocate the hottest spot by careful scanning the orifice opening. Temperature readings increased to 506 ± 2.5 °C, and topped at 529 °C. After opening the orifice vigorous venting with schlieren of clear hydrothermal fluid leaving the orifice could be observed. Fluid sampling failed ☹.

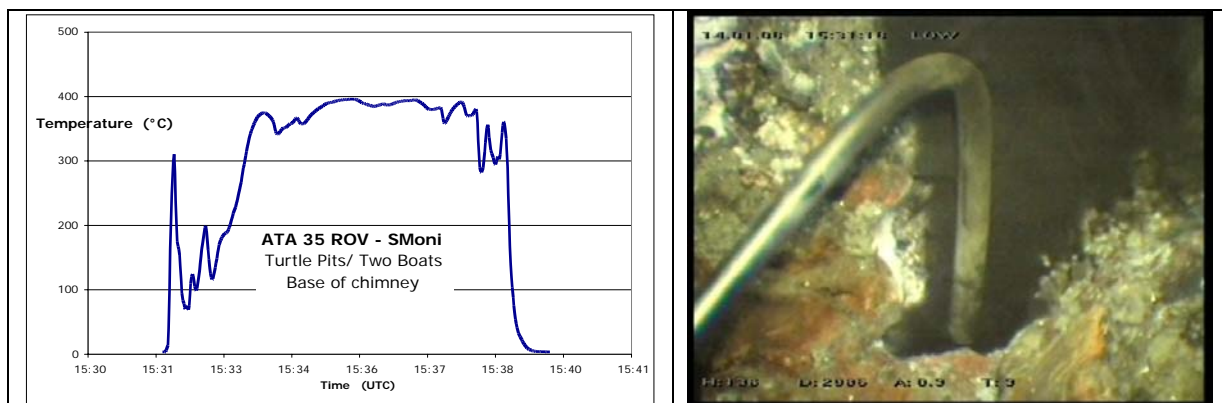

Fig. 2.4.4.5: Station ATA 35 ROV, Turtle Pits. Temperature readings were taken in the same orifice at the base of the Two Boats black smoker, but with the SMoni offline sensor+logger combination. SMoni uses different thermistor technology than that used in the KIPS sensors. Maximum temperature obtained was **396 °C**. However, the offline design of the probe makes a systematic search for the tiny spot with the hottest temperature in the orifice impossible. (Note: The SMoni logger was unfortunately flooded during the next use at station ATA 42 ROV.)

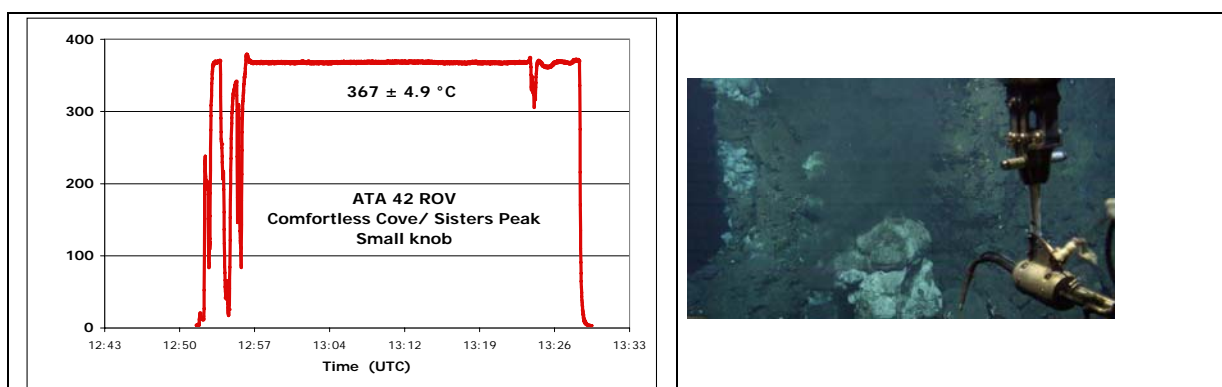

Fig. 2.4.4.6: Station ATA 42 ROV, Comfortless Cove. Temperature readings and fluid sampling were at a small knob in the top region of the Sisters Peak chimney. Average over 20 minutes: **367 ± 4.9 °C**, $T_{max} = 379$ °C, KIPS fluid samples 42 ROV-2 to -5 taken and Ti-Major D1 42-ROV-7 filled. KIPS fluid samples 42 ROV-11 to -14 were taken without temperature reading because the cable had been cut during handling.

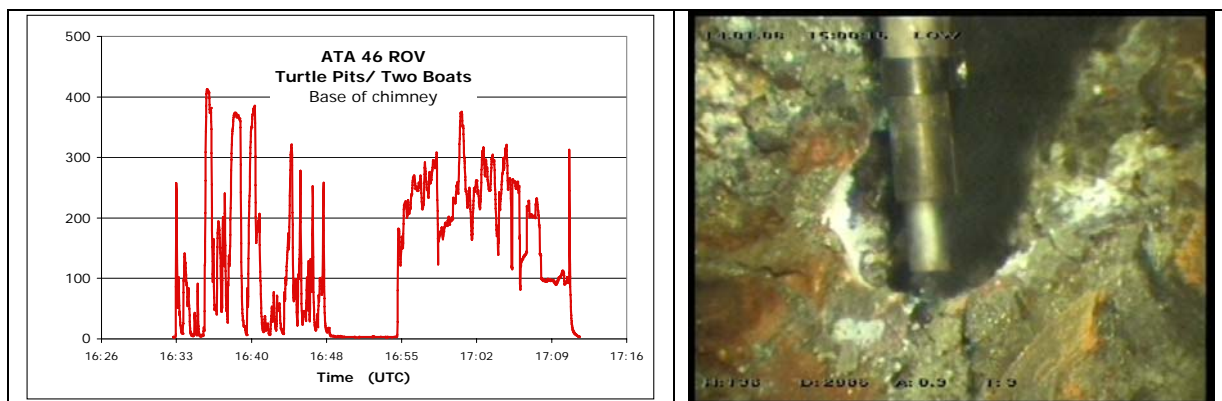

Fig. 2.4.4.7: Station ATA 46 ROV, Turtle Pits. KIPS fluid samples 46 ROV-7 and -8 were taken from the same orifice at the base of the black smoker as three days before (35 ROV). Meanwhile, a 20 cm tall chimney was re-grown over this period. After collapse of the new small chimney the venting from the orifice was found to be significantly less vigorous than during the previous visit. The feeding outlets must have plumbed by fresh precipitates. There was no accurate temperature control during fluid sampling because the T sensor had been displaced from the tip of the sampling nozzle. A maximum temperature of 412 °C was recorded.

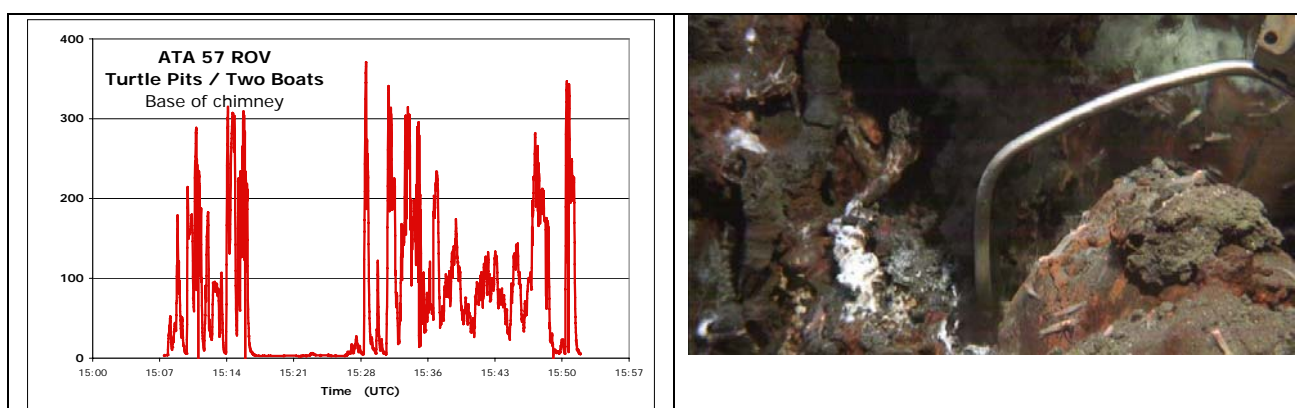

Fig. 2.4.4.8: Station ATA 57 ROV, Turtle Pits. KIPS fluid samples 57 ROV-2 to -5 collected again at base of chimney Two Boats. The orifice was now even more plumbed, and fluid flow was significantly reduced. Every attempt to reopen the orifice failed. The maximum temperature reading was 371 °C.

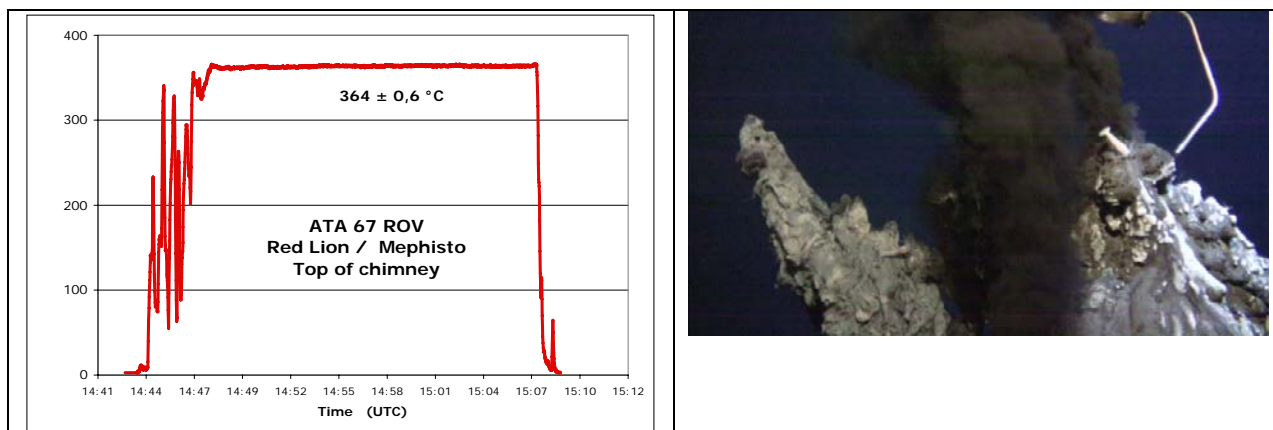

Fig. 2.4.4.9: Station ATA 67 ROV, Red Lion. A newly opened orifice in the summit region of the Mephisto chimney was sampled with Ti Major D2, 67 ROV-3, and KIPS fluid samples 67 ROV-4 to -8. Clear fluid was leaving the outlet of KIPS. Temperatures were 364 ± 0.6 °C with a maximum of 366 °C.

Chemical composition

On-board measurements comprised pH, Eh, concentrations of oxygen, sulfide, chloride and Fe speciation. For selected samples, the concentrations of dissolved H₂, CH₄, CO₂ and CO were also quantified (see chapter on Gas Chemistry). Analyses were performed in order to ascertain the quality of sampled hydrothermal fluids (i.e., the degree of admixed seawater) and to provide an initial characterization of fluid composition and characteristics, particularly with respect to phase separation. Results are presented in Figures 2.4.4.10 to 2.4.4.13 and Tables A1 and A2 (Appendix).

Turtle Pits (Two Boats)

Sampling the Two Boats chimney with the Kiel ROV 6000 turned out to be extremely difficult. Orifices with vigorous venting at the top of the smoker were inaccessible for the ROV. In addition, fluid sampling failed during the first attempt in 35 ROV. However, hydrothermal fluids were collected 1 m above, and at the base of the Two Boats chimney. However, the temperature probe was displaced from the sampling nozzle such that sampling was not guided by the temperature maximum in the orifice and more diluted fluids were sampled. Consequently, the pH range is wide between 2.8 and 6.6 in these samples. The sample with the lowest pH (57 ROV-4) displays the highest Fe concentration of 3.9 mM, and maximum sulfide concentrations of 4.8 mM were measured. Chlorinity in these Turtle Pits fluid samples is significantly reduced compared to seawater, ranging between 300 mM and 550 mM. This can only be caused by phase separation of the fluid in the subseafloor, at P/T conditions above the critical point of seawater (<3000 m, >405 °C) and the emanation of the low-salinity vapor phase.

This year's results are in good agreement with the chemical signature of fluids sampled at the same chimney in 2005 and 2006 (endmember chloride concentration: 270 mM; endmember Fe concentration: 4 mM, endmember H₂S concentration: 4.2 mM). It may be suggested from these results that the Two Boats chimney is constantly emanating a vapor phase since 2005, and, probably, the general chemical composition will be found to be as constant. Quantification of the relative percentage of hydrothermal fluid in the collected samples will be performed in the home laboratory, allowing the calculation of endmember compositions.

Comfortless Cove (Sisters Peak)

Fluids at the chimney structure Sisters Peak have been collected at 3 different orifices: one at the base of the chimney (42 ROV-2 to 42 ROV-7) and two others at the top (42 ROV-11 to 42 ROV-14). Due to difficulties in accessing the small orifices at the top, those samples contain a high amount of admixed seawater, expressed in pH values >5.6 . The pH values for samples from the bottom orifice range between 3.4 and 6.8, corresponding to total Fe concentrations between 3.7 mM and 0.07 mM. The best quality sample contains 9.7 mM H_2S and 310 mM Cl; phase separation with the emanation of a low-Cl vapor phase is evident. As Two Boats, the Sisters Peak chimney has been sampled before, in 2006. Recent results for the concentrations of Fe, H_2S , and Cl are in reasonable agreement with data obtained in 2006 (endmember Fe concentration: 3.8 mM; endmember H_2S concentration: 8 mM; endmember Cl concentration: 220 mM). Again, this confirms stability in fluid composition as already observed in Turtle Pits. The chlorinity seems to be somewhat higher when compared to 2006, which could result from slight changes in P/T conditions of phase separation. However, measured data are not yet endmember-corrected.

Red Lion (Mephisto)

In the Red Lion field, six fluid samples were collected from a collapsed beehive on top of the Mephisto structure. Temperature measurements during KIPS sampling (15 minutes) recorded stable 363 °C. Fluid pH ranges between 2.8 and 5.1. A chloride concentration of 540 mM (median of 5 samples) indicates that phase separation is not a process currently taking place. Total Fe concentrations vary between 0.25 and 0.93 mM. H_2S concentrations display a maximum value of 7.6 mM. Again, concentrations of Fe, Cl, and H_2S measured during this cruise are comparable to samples from 2005 and 2006, attesting to an overall stability in fluid composition.

Compositional differences between hot hydrothermal fluids emanating at Red Lion and those emanating at Turtle Pits and Comfortless Cove are a clear function of temperature and phase separation.

Wideawake

At Wideawake, diffuse fluids emanate in an area of intense mussel inhabitation. Fluids were collected at two different locations (37 ROV-1 to 37 ROV-5; 37 ROV-10 to 37 ROV-13). Measured temperatures (KIPS) were 4 and 16 °C. The pH ranges between 7.05 and 7.5. Fe concentrations are as high as 25 μM . Concentrations of H_2S range between 1.2 and 76 μM . There is no clear correlation between H_2S and Fe concentrations. The measured chlorinity is seawater-like, with a median value of 550 mM.

Comfortless Cove (Golden Valley)

Diffuse fluids sampled at a mussel field (locality "Clueless") in the Golden Valley area seep at constant temperatures between 8 and 9°C. The pH ranges between 6.8 and 7.6. Fluids contain up to 43 μM Fe and up to 56 μM H_2S . Similar to diffuse fluids from the Wideawake mussel field, the H_2S concentrations do not correlate with respective Fe concentrations, but with pH.

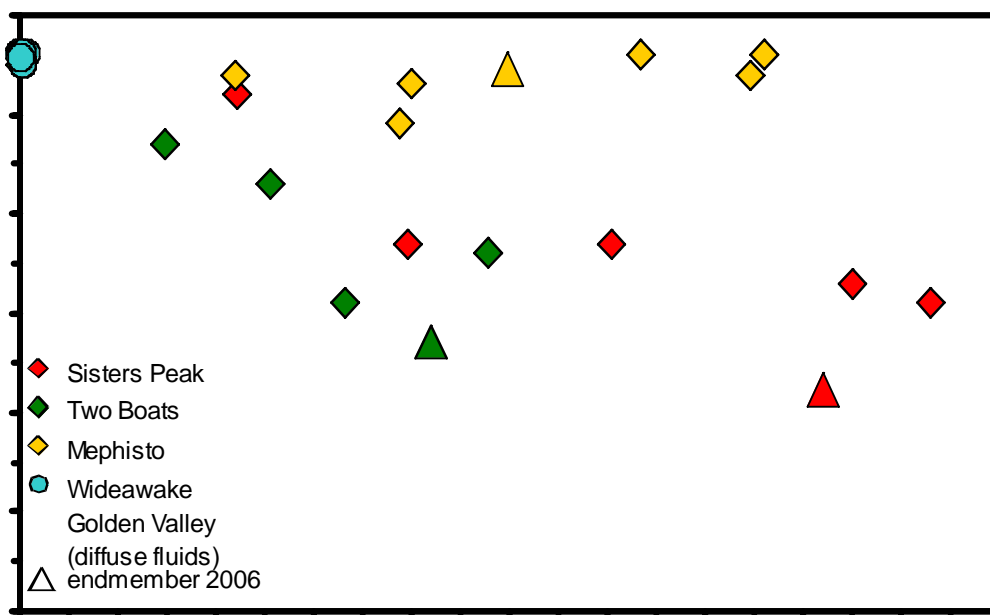

Fig. 2.4.4.10: Crossplot of H_2S and Cl concentrations for hot and diffuse hydrothermal fluids.

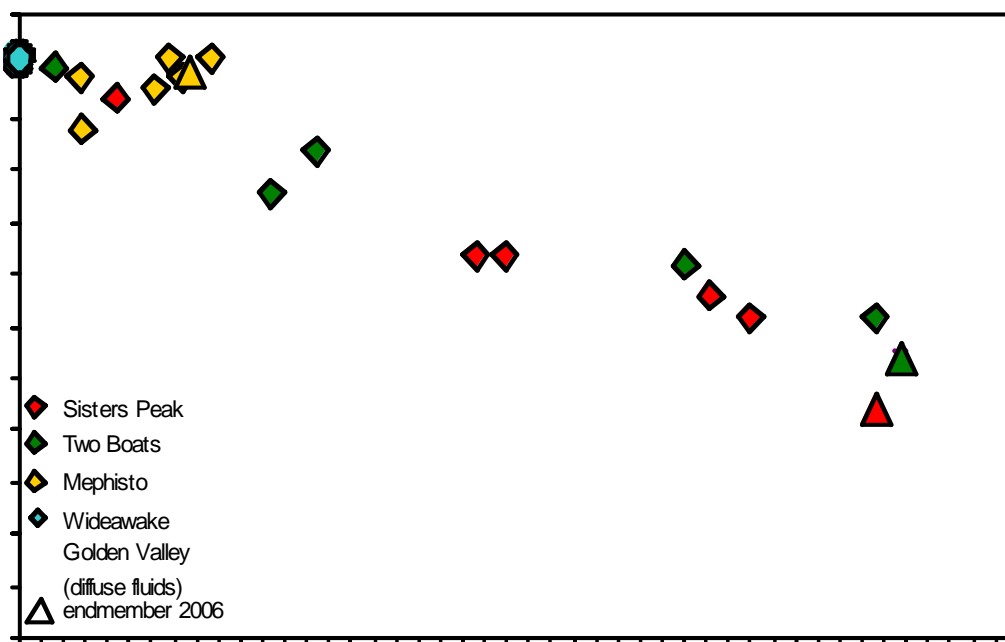

Fig. 2.4.4.11: Crossplot of $Fe(II)$ and Cl concentrations for hot and diffuse hydrothermal fluids.

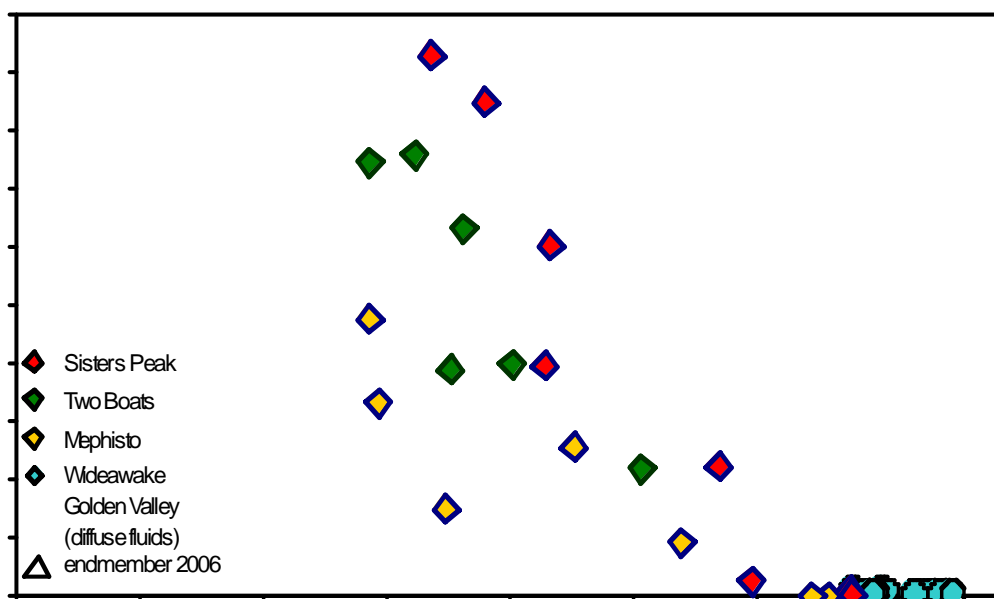

Fig. 2.4.4.12: Crossplot of pH and H₂S concentrations for hot and diffuse hydrothermal fluids.

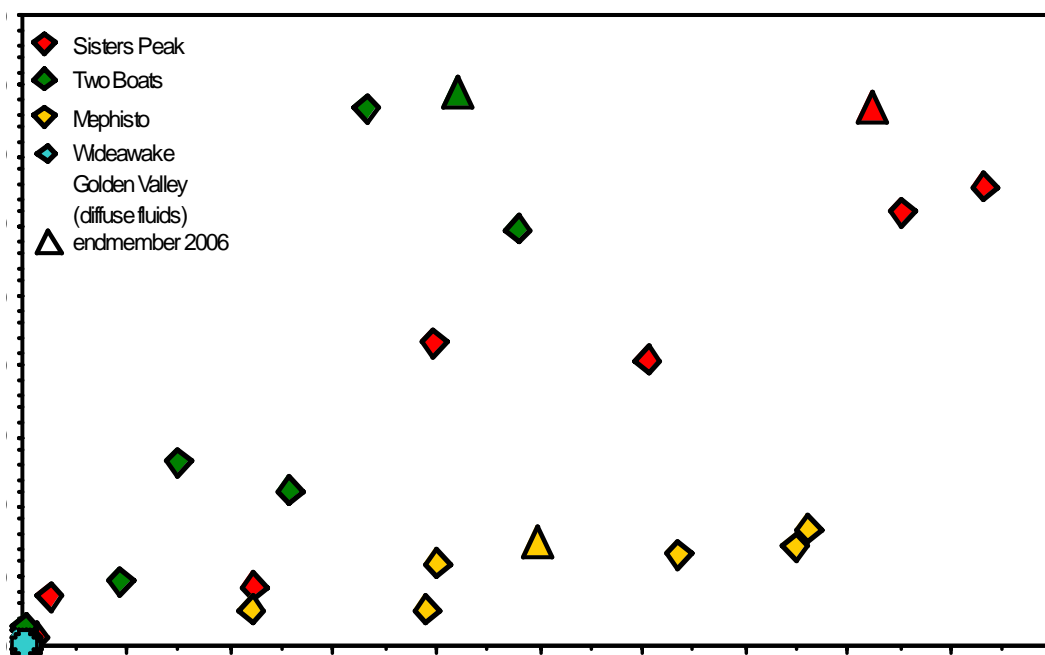

Fig. 2.4.4.13: Crossplot of H₂S and Fe(II) concentrations for hot and diffuse hydrothermal fluids.

2.4.4.4 *The chemical composition of hydrothermal fluids – Perspectives*

The chemical and isotopic composition of hydrothermal fluids is largely governed by the interaction of rocks and heated seawater percolating through the oceanic crust. Additional effects derive from phase separation of the hydrothermal fluid into a low-chlorinity, gas-rich vapour phase and a high-chlorinity brine phase. This process is accompanied by a strong partitioning of certain elements into either one phase. The latter aspect, i.e. phase separation, is most relevant for the two hydrothermal vent fields at Turtle Pits (Two Boats) and Comfortless Cove (Sisters Peak), as evident from respective chlorinity data measured on-board. In contrast, the Red Lion hydrothermal system shows no indication of phase separation serving as a reference site hosted in the same geological setting. This provides the unique opportunity to study partitioning effects induced by phase separation.

Resulting from these general characteristics, subsequent measurements in the home laboratories will aim to discriminate compositional effects derived from water-rock interaction from those caused by phase separation. The analytical approach comprises a wide array of analytical techniques for measuring the concentrations of major, minor and trace elements and the isotopic compositions for selected elements (Ca, Sr, Cl, Hf, S, C, H, O) in the hydrothermal fluid. **The ultimate goal is a quantitative characterization of fluid composition that will represent the base for balancing the mass flux from mantle to ocean.**

2.4.5 Gas Chemistry

(Ralf Lendt, Marco Warmuth, Frederic von Guilleaume, and Richard Seifert)

CH₄, H₂, CO, and CO₂ were measured on board by gas chromatography. Focus was given to hot fluids to obtain information on the sub-surface hydrothermal processes and on diffuse vents emphasizing on the energy and food supply of vent organisms. In addition, the stable carbon and hydrogen isotope ratio of methane from the fluid samples will be measured in the isotope laboratory at the IfBM.

The water samples for these analyses were collected from 11 CTD stations and 6 ROV dives. For ROV dives, samples were obtained by three different devices namely the KIPS, titanium in situ gas samplers (MAJORS) and an isobaric sampler.

In addition, hydrogen was monitored within incubation experiments conducted by M. Perner on the metabolism of microorganisms present in hydrothermal fluids (Section 2.4.2).

Methods

In order to analyze dissolved CH₄, H₂, CO and CO₂, the fluid samples were degassed using a vacuum degassing technique modified from the method described by Rehder et al. (1999). In brief, water sample is drawn directly into a pre-evacuated flask which is then filled to only about half of the total flask volume. During this sampling, most of the dissolved gas exsolves into the remaining headspace. The amount of water taken was measured with a flow meter (Engolit Flow Control 100S/Typ DMK). The extracted gas phase is subsequently recompressed to atmospheric pressure and transferred to a gas burette. The mole fraction of the analytes are determined by gas chromatography on aliquots of this gas.

For the determination of dissolved CH₄ a CARLO ERBA (GC 4000) gas chromatograph equipped with a flame ionization detector was used in connection with an integration software. Helium was used as carrier gas, and separation was performed using a 4m Al₂O₃ column run isothermally at 130 °C.

CO, CO₂, and CH₄ concentrations of extracted gas were determined using a gas chromatograph (CARLO ERBA, 8000 top). 0.1 to 1 ml of gas was injected on and separated by a 10m long packed column, passed a thermal conductivity detector to a methanizer transforming all oxidized carbon species into CH₄ which then is quantified by a flame ionization detector. Data are recorded for both detectors by a PC based commercial integration software. Carrier gas was helium, oven temperature was 3 min isotherm 60°C, 40°/min to 120° kept for 10 min.

A TRACE Ultra gas chromatograph (Thermo Electron) equipped with HaySep Q, and Molecular Sieve 5 A columns was used to determine the H₂ and CH₄ concentrations of the extracted gas. The run was performed isothermally at 40 °C, helium was used as carrier gas. The eluted gas was detected via a PDD (pulsed discharge detector, VICI).

After transferring the remainder of the gas into a 20 ml glass vial, the septum is sealed with silicone on the outside and with degassed saturated salt solution on the inside. ROV samples are listed in Table 2.4.5.1; CTD samples are listed in Table 2.4.5.2.

Table 2.4.5.1: ROV samples studied for gas content of fluids

Station	KIPS	Ti-MAJOR	IB
ATA 35 ROV	1	2	
ATA 37 ROV	2		
ATA 42 ROV	1		1
ATA 46 ROV			1
ATA 52 ROV	3		
ATA 67 ROV		1	

Table 2.4.5.2: Samples obtained by CTD-Rosette studied for gas content

Station	samples	H ₂	CH ₄	CO
ATA 31 CTD	6	6	6	
ATA 32 CTD	6	6	6	5
ATA 33 CTD	5	4	5	5
ATA 38 CTD	8	8	8	
ATA 39 CTD	8	8	8	
ATA 40 CTD	7		7	
ATA 44 CTD	6		6	6
ATA 45 CTD	8		8	8
ATA 47 CTD	7		7	
ATA 48 CTD	9	5	9	
ATA 49 CTD	4		4	
ATA 64 CTD	6		6	6

Preliminary results

CTD/Rosette samples were mainly obtained from the Turtle Pits area. Highest concentrations H_2 were found at 2740m depth with 4.4 nM, while CH_4 where up to 1.72 nM. CO was found in concentrations of about 20 nM showing no positive correlation with CH_4 or H_2 . An overview on the content of CH_4 and H_2 in water samples studied is given in Fig. 2.4.5.1

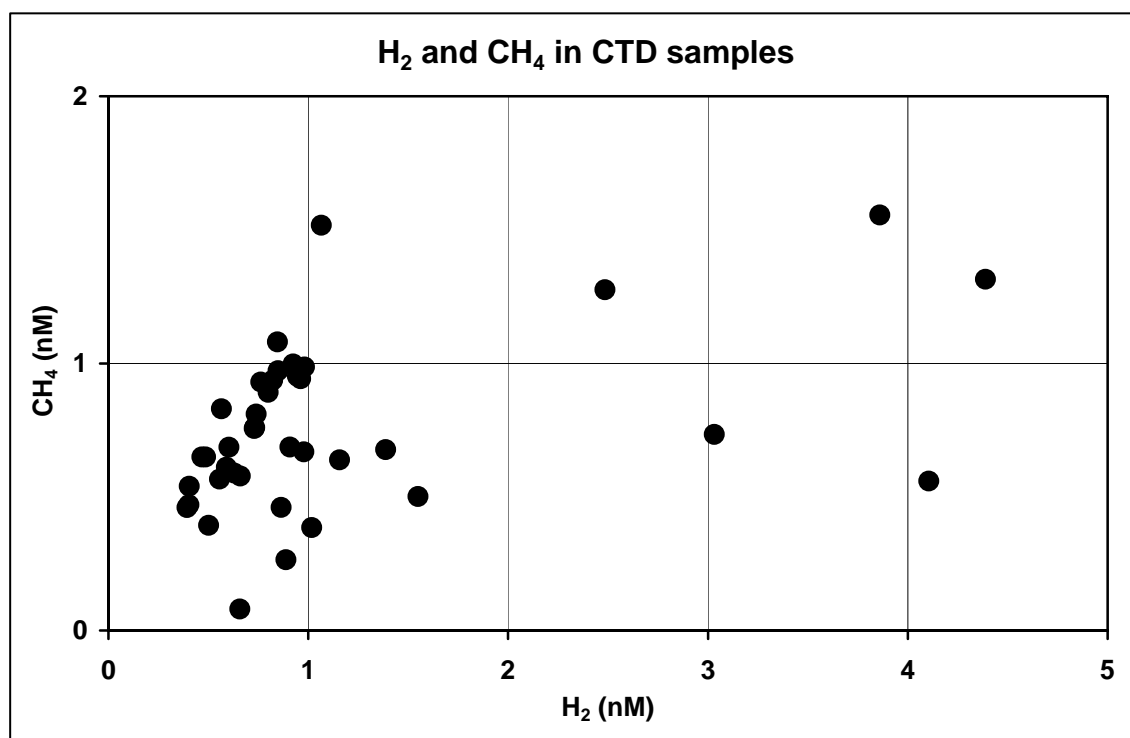

Fig. 2.4.5.1: Concentrations of CH_4 and H_2 in water samples obtained by CTD/Rosette.

A main objective of the cruise was to take samples of black smoker fluids by avoiding degassing of the sample prior to on board analysis. For this purpose, a newly built isobaric sampler (IB) was used for the first time. Figure 2.4.5.2 shows the IB brought into position by the Rick Master of the ROV Kiel 6000 during dive ATA 42 ROV at the black smoker Sisters Peak located in the area Comfortless cove (see Table 2.4.5.3). Comparison between the data obtained from the fluid taken by IB and those obtained from a sample taken by KIPS at the same location

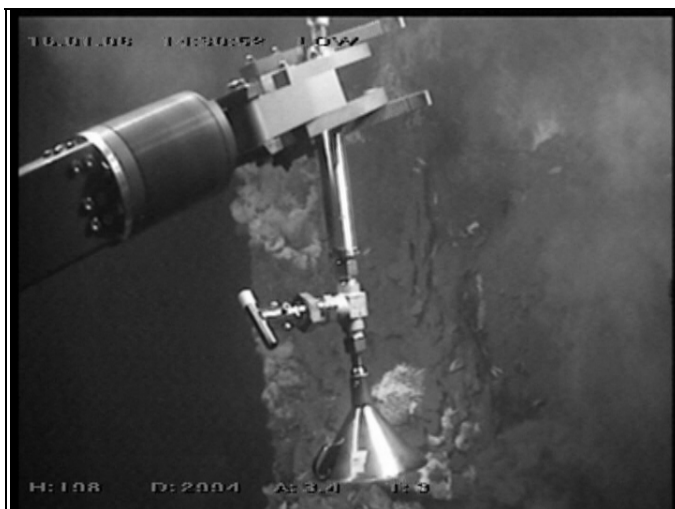

Fig. 2.4.5.2: Sampling of Sisters Peak with the IB-sampler

illustrates sampling of hot hydrothermal fluids by KIPS to be not suitable for studies of gas chemistry. Though from its design, the KIPS allows much better gaining samples of pure fluid when compared to the IB. Samples of high quality could also be retrieved using titanium samplers (MAJOR). Especially for the smoker Two Boats of the Turtle Pits hydrothermal field (figure 2.4.5.3), samples obtained this way showed the expected high gas concentrations (Table 2.4.5.3) exceeding those determined on KIPS samples during earlier cruises by far. The concentration of H_2 was close to 0.5 mM, exceptionally high for a fluid of

a system hosted by basaltic rocks, with a H₂/CH₄ ratio of 25.5. In view on the high temperatures of well above 400°C measured for the fluids during dive ATA 42 ROV, and the visual observations, we assume to have investigated an hypercritical fluid. New data on the gas content were also obtained for the fluid of the smoker Mephisto with 270 μM of H₂, 14 μM of CH₄, and 8 μM of CO.



Fig. 2.4.5.3: Sampling of Two Boats with the Ti-Major sampler

Table 2.4.5.3: Gas content of selected hot black smoker fluids

Area / sample	H ₂ (μM)	CH ₄ (μM)	CO ₂ (μM)	CO (μM)
Turtle Pits, Two Boats				
ATA 35 ROV, Major D2	406	16	12956	4
Comfortless Cove, Sisters Peak				
ATA 42 ROV, IB	204	6.8	6745	1.5
ATA 42 ROV, KIPS C9	8.5	0.3	221	0.05
Red Lion, Mephisto				
ATA 67 ROV, Major DS	270	14	n.d.	8

Investigations of fluids from diffuse vents were accomplished for samples of the Wideawake field at Turtle Pits and the Golden Valley at Comfortless Cove (Table 2.4.5.4). These data are of high relevance for the biological studies of vent faunas.

Table 2.4.5.4: Gas content of selected diffuse fluids

Area / sample	H ₂ (nM)	CH ₄ (nM)	CO ₂ (μM)	CO (nM)
Turtle Pits, Wideawake				
ATA 37 ROV, KIPS C7	197	15	65	113
ATA 37 ROV, KIPS A1	194	22		105
Comfortless Cove, Golden Valley				
ATA 42 ROV, KIPS A1	355	36	138	992

2.4.6 Hydrothermal Symbioses

(Jillian Struck and Nicole Dubilier)

1) Genomic analyses: Our main goal for this cruise was to collect and prepare *Bathymodiolus* mussels for genomic analyses of their symbionts. Knowledge of the genomes of chemosynthetic symbionts provides us with an invaluable catalogue of their potential metabolic pathways and can show us how the symbionts gain energy from hydrothermal fluids and pass these on to their hosts. These genomic analyses can then provide the basis for examining which pathways are actually used by the symbionts under different environmental conditions through transcriptomic and proteomic analyses.

As yet, no one has been able to cultivate the symbionts of animals from hydrothermal vents and cold seeps, making direct sequencing of their genomes from cultured cells impossible. Metagenomics, the sequencing of genomes of organisms from the environment, provides an ideal tool for gaining metabolic and genomic information about uncultivable bacteria. In 2007, we were successful in obtaining a grant from the French sequencing facility Genoscope to sequence the metagenome of the bacteria in *Bathymodiolus* gill tissues. These include the methane- and sulfur-oxidizing symbionts as well as a novel bacterial parasite that lives in the nuclei of bathymodiolin mussels. Since the host genome is so much larger than the bacterial genomes (estimated sizes of 200-300 megabases (MB) for the host and 3 - 5 MB each for the bacteria), we can not simply provide Genoscope with *Bathymodiolus* gill tissues. Our sequencing allotment of 300 MB would be “wasted” on sequencing of the host instead of the bacterial genes. It is therefore essential to physically separate the bacteria from the gill tissues, and such separations or enrichments of the bacterial fraction are best done on fresh material.

To separate the *Bathymodiolus* bacteria from host gill tissues we used density gradient centrifugation. In this method, a density gradient is created by carefully layering decreasing concentrations of a sugar compound called Histodenz (here 70 – 5%) on each other. Centrifugation of particles with different sizes and weights causes them to migrate to different density gradient layers. When a mixture of host tissue and bacteria is centrifuged in such a gradient, layers enriched in bacterial cells can thus be separated from host tissues.

To prepare tissues for density gradient centrifugation, we dissected the gills out of 6 freshly collected mussels from Wideawake and Clueless (see Sampling List). Care was taken to use only a single mussel individual for each gradient, to ensure that bacterial strain variability between host individuals does not complicate the genomic analyses. One of the two gills of each mussel was fixed for morphological and molecular analyses of the bacteria in the home laboratory (transmission electron microscopy, fluorescence in situ hybridization, PCR analyses of phylogenetic and functional genes) while the other gill was prepared for genomic analyses by homogenization on ice in 1X phosphate buffered saline (PBS). For some gradients, the homogenate was filtered through 12 and 5 µm filters before centrifugation, in others unfiltered homogenate was placed directly on the gradients. Gradients were centrifuged in the cold room (ca. 10°C) for 1.5 – 2 h at 5000 RPM. In all gradients a similar layering pattern was observed: 1) at the top of the gradient (5 – 10% Histodenz) lay a thin white fraction, followed by a light brown fraction with 2 sublayers, the top one light brown (~20% Histodenz), the bottom one milky brown (~30% Histodenz). The next fraction (~40% Histodenz) was thick and dark brown, followed by a light brown fraction with a crystalline appearance (~50% Histodenz). The bottom layers (~60 - 70% Histodenz) were all clear.

Fractions were removed from the gradient in 500 µl steps and a subsample from each fraction was fixed for fluorescence in situ analyses (FISH) with probes specific to the bacteria in *Bathymodiolus puteoserpentis* from Logatchev. Analysis of the gradients with specific probes on board was difficult because the probes for the sulfur- and methane-oxidizing symbionts did not show a signal, presumably because these probes had too many mismatches to the symbionts from the Wideawake mussels. Using a probe for the intranuclear parasite, we only saw these bacteria in a single fraction (thick, dark-brown layer) from a single individual (46ROV1-1) in very low abundance. This layer was characterized by high abundances of bacteria presumed to be the sulfur- and methane-oxidizing symbionts based on DAPI-staining and their hybridization signal using the general bacterial probe EUB338. Contaminating host tissue concentrations were very low in this fraction. DAPI and EUB338 analyses of the top white layer of the gradients indicated that these were highly enriched in sulfur-oxidizing symbionts. Further analyses of these gradients in the home laboratory with probes specific to the Wideawake symbionts will allow us to decide which gradients we will use for our metagenomic analyses.

2) In situ fixation chamber DieFast: One of our main goals within the SPP 1144 is to understand the interactions between hydrothermalism and biology. To date, all animals from hydrothermal vents and other deep-sea environments are brought up to the surface and dissected and fixed on board. Most of the sites we are studying within the SPP 1144 are at 3000 m water depth. It thus can take up to 3 hours after the animals have left their environment before we can prepare them, often even longer if animal collection is not the last station for the ROV work of that day. This is a problem for analyzing the metabolic pathways the animals use in their environment. Changes in the transcription of genes to messenger RNA (mRNA) can occur within minutes, changes at the protein level within hours. We therefore designed an in situ fixation chamber, called DieFast, for fixing mussels or other biological samples directly on the seafloor within minutes of their collection (Fig. 2.4.6.1). DieFast consists of a fixation chamber with a rubber sealed lid (volume: 3 liters) that is connected through tubing to 3 syringes (each 100 ml). The chamber weighs 17 kg in air and easily fits on the ROV porch. Before deployment, the chamber and the tubing are filled with seawater. The syringes are filled with 40% formalin with stoppers placed in the syringes to prevent the formalin from running through the tubing into the fixation chambers. During deployment, the organisms are placed in the chamber, and the lid is closed and the stoppers released mechanically by the ROV arm. The 300 ml of 40% formalin are diluted to 4% in the fixation chamber, which is an ideal concentration for fixing biological samples for morphological analyses of their mRNA (mRNA FISH) and proteins (immunohistochemistry).

Our first (and only) deployment of DieFast at the Wideawake site (ATA 37 ROV 9) was highly successful. Mussels were collected singly or in clumps of 3-5 individuals and placed in the chamber using the ROV Orion arm. Closing of the chamber lid and release of the stoppers using the appropriate monkey fists was easily and quickly performed by the ROV pilots with the Orion arm. The entire time for deployment including the collection of mussels was less than 30 minutes. After recovery of the ROV, we examined the mussels: they were almost all intact and had clearly all been fixed by the formalin. Analyses of these specimens in the home laboratory and comparison with mussels fixed on board will reveal the importance of fixing animals in-situ.

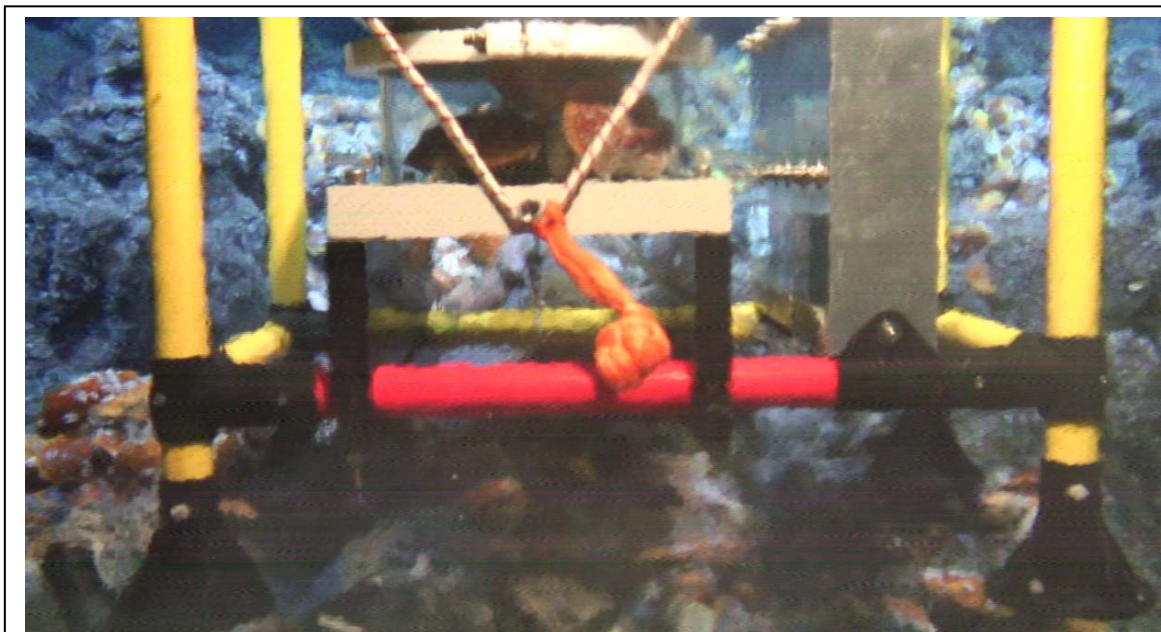

Fig. 2.4.6.1: DieFast during deployment at Wideawake. The mussels have already been placed in the fixation chamber and its lid has been closed using the elastic strap and the orange monkey fist attached to it. The syringes with formalin are on the right of the chamber behind the metal casing.

3) Collection of animals for biogeography

Our final goal for this cruise was to collect as many animals as possible for biogeography analyses (Table 2.4.6.1). One of the goals within the SPP 1144 is to better understand how ridge morphology and ocean currents influence the dispersal of vent organisms along the ridge. To do this, we compare the phylogenetic relationships of animals from different vent sites using genes as indicators of their relatedness. For example, if animals from Logatchev on the northern Mid-Atlantic Ridge were more closely related to animals from other northern MAR vents than to those from the southern MAR vents, this would suggest that geological barriers at the equator including the large offset of the ridge-axis prevented gene flow between southern and northern MAR vents. In addition to collecting mussels, we also collected at least two species of shrimp (*Rimicaris exoculata* and *Mirocaris fortuna*), and possibly a third species (*Opaepele* sp.), first found and described during the 2007 Meteor M68/1 cruise to the southern MAR. We were extremely fortunate to find a clam individual (*Calyptogena* sp.) at Clueless (ATA 52 ROV 11). This is only the second specimen that we have found at 5°S. These clams are extremely rare on the MAR and are only known from Logatchev and 5°S. We have only found dead clam shells at Logatchev but were recently given 5 alcohol-fixed *Calyptogena* sp. individuals from Logatchev by Dr. Andrey Gebruk (Shirshov Institute of Oceanology, Moscow). Phylogenetic analyses of the Logatchev and the 5°S individuals will show how these clams are related to other clams from vents and seeps around the world and may reveal their geographic origin for colonizing the MAR.

Table 1: Animals collected during L'Atalante cruise MSM06/3 to 5°S

Station number	Site	Sample	Sample treatments	Gradient centrifugation
ATA 35 ROV 18	Turtle Pits	Slurp	<i>R. exoculata</i> samples for FISH and DNA <i>Mirocaris fortuna</i> samples for FISH and DNA possibly 3 <i>Opaepele</i> sp. individuals for FISH and DNA	
ATA 37 ROV 7	Wideawake	Mussel net	<i>Bathymodiolus</i> sp. samples for FISH, DNA, RNA, electron microscopy whole <i>B. sp.</i> frozen for DNA	2 Individuals
ATA 37 ROV 8	Wideawake	Slurp	<i>R. exoculata</i> samples for FISH and DNA	
ATA 37 ROV 9	Wideawake	Die Fast	Whole <i>B. sp.</i> fixed in situ for FISH	
ATA 46 ROV 1	Wideawake	Mussel net	<i>B. sp.</i> samples for FISH, DNA, and electron microscopy	1 Individual
ATA 46 ROV 4	Wideawake	Slurp	Whole frozen <i>B. sp.</i>	
ATA 46 ROV 5	Wideawake	Slurp	Small <i>B. sp.</i> frozen whole for DNA	
ATA 52 ROV 11	Clueless (near Golden Valley)	Mussel net	<i>B. sp.</i> for FISH, DNA, RNA, electron microscopy <i>Calyptogena</i> sp. for FISH, DNA, RNA, electron microscopy Whole <i>B. sp.</i> frozen for DNA	2 Individuals
ATA 57 ROV 7	Wideawake	Mussel net	<i>B. sp.</i> for FISH, DNA, RNA, electron microscopy <i>B. sp.</i> for cultivation experiments Whole <i>B. sp.</i> frozen for DNA	1 Individual
ATA 67 ROV 1	Red Lion - Mephisto	Slurp	Crab - <i>Segonzacia</i> , for DNA	
ATA 67 ROV 2	Red Lion - Mephisto	Slurp	<i>R. exoculata</i> samples for FISH and DNA	

2.4.7 Paleooceanography

(Almuth Harbers)

Goals

During Leg 2 paleoceanographical investigations were focused on collecting planktonic foraminifera and pteropods. Referring to the project **Future Ocean** - "Changing habitats of calcareous plankton in the Green House World" planktonic foraminifera and their response to climate change is going to be studied. For the next hundred years a surface ocean warming of 3°-5°C is expected (Mitchell, 2005). An estimated pH drop of 0.7 units in surface waters is the effect of absorption of 50% of fossil fuel CO₂ emissions (Caldeira and Wickett, 2003).

One goal is to show the impact of acidification and surface ocean warming on planktonic foraminifera with reference to former investigations.

Investigations will include faunal inventory, assemblage composition, size distribution and shell weights, and chemical and isotopic composition regarding to $\delta^{13}\text{C}$, $\delta^{18}\text{O}$, Mg/Ca and Sr/Ca.

Methods

Samples were taken two times a day. With a, in the ship's system integrated pump, 3m³ seawater were filtered over a 63µm sieve. The water was pumped from below the vessel, in a depth of 4-5m. The samples were washed with fresh water and put into a vial with nearly 120ml ethanol. 32 samples were taken between 09.01.2008 and 29.01.2008. The first two samples RD 1 and RD 2 have only a volume of 1m³. Because of low inventory volume was then increased to 3m³.

Other 18 samples were taken on several days with an Apstein net (100µm). Samples were taken in depth sections of 0-10m, 10-20m, 20-30m, 30-40m and 40-50m. The net with an aperture of 17cm was deployed and lifted five times in each section, so nearly 1m³ got filtered in each section. The samples were washed with fresh water and stored with nearly 120ml ethanol in vials. Only three depth sections were done at sampling station TP 2 because the assisting Crew had to work on other stations.

Taking water samples for isotopic analyses took place once a day between 14.01.2008 and 29.01.2008. Seawater was collected with the water pump right before or right after the other samplings (pump and/or Apstein) took place. They got stored in a 100ml vial. Because of missing Mercury Chloride (HgCl₂) solution in the first days of cruise, only few samples were intoxicated to stop bacterial activity.

Any analyses will be done onshore at the IFM-GEOMAR, Kiel.

Sampling stations

Pump

Sample	Date	UTM/start	UTM/end	local time	Latitude/start	Longitude/start	Latitude/end	Longitude/end
RD 1	09.01.2008	11:36	12:30	-3	07°03.443S	27°45.880W	07°02.250S	27°37.700 W
RD 2	09.01.2008	16:00	17:13	-3	07°02.144S	27°28.445W	07°02.440S	27°27.723W
RD 3	10.01.2008	9:46	12:02	-2	06°42.355S	25°07.930W	06°39.245S	24°46.878W
RD 4	10.01.2008	15:50	18:06	-2	06°34.055S	24°11.740W	06°31.088S	23°51.278W
RD 5	11.01.2008	9:50	12:22	-2	06°09.079S	21°22.808W	06°05.390S	20°57.900W
RD 6	11.01.2008	15:54	18:39	-2	06°00.368S	20°23.920W	05°56.585S	19°57.322W
RD 7	12.01.2008	9:45	11:40	-1	05°34.876S	17°30.957W	05°32.145S	17°12.581W
RD 8	12.01.2008	14:33	17:28	-1	05°27.412S	16°45.324W	05°22.640S	16°22.940W
RD 9	13.01.2008	9:01	11:39	-1	05°05.019S	14°17.077W	05°01.616S	13°52.626W
RD 10	13.01.2008	14:48	17:32	-1	04°57.474S	13°22.850W	04°53.745S	12°57.190W
RD 11	14.01.2008	9:18	11:40	-1	04°48.379S	12°22.632W	04°48.583S	12°22.427W
RD 12	14.01.2008	14:50	17:27	-1	04°48.594S	12°22.412W	04°48.590S	12°22.416W
RD 13	17.01.2008	10:55	13:45	-1	04°48.857S	12°22.332W	05°00.285S	11°59.704W
RD 14	17.01.2008	15:49	18:43	-1	05°09.764S	11°45.261W	05°06.959S	11°42.113W
RD 15	18.01.2008	9:24	12:28	-1	04°48.442S	12°22.314W	04°48.610S	12°22.346W
RD 16	18.01.2008	15:50	18:51	-1	04°48.588S	12°22.359W	04°48.586S	12°22.364W
RD 17	20.01.2008	10:11	12:57	-1	04°48.121S	12°22.282W	04°48.198S	12°22.268W
RD 18	20.01.2008	15:53	18:13	-1	04°48.193S	12°22.275W	04°48.200S	12°22.267W
RD 19	22.01.2008	11:36	13:44	-1	04°47.395S	12°22.604W	04°47.389S	12°22.599W
RD 20	22.01.2008	17:05	19:45	-1	04°47.391S	12°22.600W	04°47.398S	12°22.600W
RD 21	24.01.2008	9:11	11:36	-1	04°48.626S	12°22.721W	04°48.852S	12°22.297W
RD 22	24.01.2008	16:50	19:46	-1	04°48.044S	12°22.425W	04°48.114S	12°22.347W
RD 23	25.01.2008	9:36	12:02	-1	04°56.021S	11°39.493W	04°56.506S	11°36.996W
RD 24	25.01.2008	14:57	17:37	-1	04°56.501S	11°37.002W	04°56.339S	11°37.002W
RD 25	26.01.2008	10:32	12:32	-1	03°14.099S	12°13.800W	02°53.613S	12°21.219W
RD 26	26.01.2008	15:50	18:43	-1	02°20.826S	12°33.066W	01°52.050S	12°43.476W
RD 27	27.01.2008	9:07	11:10	-1	00°34.227N	13°36.325W	00°55.074N	13°43.866W
RD 28	27.01.2008	15:26	17:17	-1	01°39.038N	13°59.752W	01°58.295N	14°06.715W
RD 29	28.01.2008	10:03	12:12	0	04°53.398N	15°10.118W	05°14.830N	15°17.890W
RD 30	28.01.2008	15:36	17:32	0	05°48.503N	15°30.120W	05°59.988N	15°34.293W
RD 31	29.01.2008	9:25	11:33	0	08°24.125N	16°26.805W	08°44.798N	16°34.351W
RD 32	29.01.2008	15:27	17:30	0	09°20.454N	16°47.439W	09°21.026N	16°48.481W

Apstein

Sample	Date	UTM/start	UTM/end	local time	Latitude	Longitude	Depth
TP 1	15.01.2008	10:31	11:37	-1	04°48.632S	12°22.354W	0-50m
TP 2	19.01.2008	15:04	15:48	-1	05°05.697S	11°39.961W	0-30m
TP 3	21.01.2008	11:00	12:20	-1	04°48.572S	12°22.450W	0-50m
TP 4	24.01.2008	15:04	16:29	-1	04°48.832S	12°22.611W	0-50m

Water samples

Sample	Date	UTM	local time	Latitude	Longitude
RDO1	14.01.2008	17:28	-1	04°48.590S	12°22.416W
RDO2	15.01.2008	16:42	-1	04°48.637S	12°22.349W
RDO3	16.01.2008	18:22	-1	04°48.117S	12°22.270W
RDO4	18.01.2008	15:50	-1	04°48.588S	12°22.359W
RDO5	19.01.2008	11:16	-1	05°05.467S	11°39.238W
RDO6	20.01.2008	13:00	-1	04°48.175S	12°22.271W
RDO7	21.01.2008	18:32	-1	04°48.617S	12°22.411W
RDO8	22.01.2008	17:05	-1	04°47.391S	12°22.600W
RDO9	23.01.2008	13:39	-1	05°05.952S	11°40.582W
RDO10 + HgCl ₂	24.01.2008	16:49	-1	04°48.044S	12°22.425W
RDO11 + HgCl ₂	25.01.2008	09:35	-1	04°56.021S	11°39.493W
RDO12 + HgCl ₂	26.01.2008	10:31	-1	03°14.099S	12°13.800W
RDO13 + HgCl ₂	27.01.2008	09:01	-1	00°33.126N	13°35.930W
RDO14 + HgCl ₂	28.01.2008	9:55	0	04°52.091N	15°09.647W
RDO15 + HgCl ₂	29.01.2008	9:23	0	08°23.714N	16°26.805W

2.4.8 Global distribution and atmospheric transport of volatile and semi-volatile polyfluorinated compounds

(Annekatriin Dreyer¹, Petra Günnewig)

¹ GKSS Research Center, Institute of Environmental Chemistry, Gesthacht, Germany

Persistent and toxic perfluorinated organic acids have been detected in high concentrations in polar biota. As these perfluorinated acids are not volatile and only partly water soluble, the mode of transport of these compounds to remote regions is not yet satisfactorily explained. Two transport modes are being thought of: directly via the water phase and indirectly by the degradation of precursors via the atmosphere. To further elucidate this problem air samples were collected at the cruise L'Atalante Recife-Dakar and analysed for organic poly- and perfluorinated compounds. These measurements will improve understanding of the long-range transport of this emerging class of organic contaminants to remote regions and lead to a better predictability.

2.4.9 Volcanic rocks

(B. Melchert, H. Paulick)

The volcanological investigations during ROV deployments focussed on mapping individual lava flow units and taking samples from flow units with stratigraphically defined age relationships. Furthermore, we used the „Vulkanitstossrohr (VSR)“ („wax corer“) in order to obtain geochemical samples from the areas immediately to the north and south of the

regional topographic high on which the hydrothermally active region at 4°48'S is located. Sample descriptions are provided in the Appendix.

Regional-scale sampling of basalt lava

The existing basalt sample set, obtained during previous visits to the area in 2005 (M64-1) and 2006 (M68-1), is restricted to an area of approximately 2 km x 2 km representing lava units from the immediate vicinities of the hydrothermally active sites. These are located on a topographically elevated portion of the ridge axis valley rising to around 2990 m below sea level [mbsl] whereas water depths increase to 3300 m at ~8 to 10 km to the north and the south (Fig. 2.4.9.1). The geochemical and isotopic compositions of this densely sampled area has been investigated as part of research projects at Kiel and Bonn and the data show that the magmas from this area are fairly homogenous in composition (unpublished data from Karsten Haase, Thomas Kokfeld and Holger Paulick). In order to determine whether the apparently increased volcanic activity in this area, generates a localized ridge with an elevation in the order of 300 m, samples from the surrounding axial valley are required.

We obtained 6 VSR samples from the north and south of the Turtle Pits area returning sufficient volcanic glass for geochemical analyses (Fig. 2.4.9.1). These data will be used to determine whether there are compositional gradients in the lavas which may provide constraints of the sublithospheric controlling parameters on volcanism in the area.

Turtle Pits and Wideawake hydrothermal sites and the 2002 (?) lava flow

The volcanology of the Turtle Pits and Wideawake hydrothermal sites has been investigated during previous cruises and documented in Haase et al. (2007). In addition, deployment of the AUV ABE during the Cruise M68-1 (2006) provided detailed sea floor images of the geological situation at the Wideawake mussel bed site. Here, a young, lobate lava flow with a black, glassy luster has partly covered pre-existing mussel beds located on top of an older lava flow with a jumbled flow top morphology. Based on the intense hydrothermal activity at Turtle Pits and the occurrence of this young lavaflow in the immediate vicinity (ca. 200 m to the east, Fig. 2.4.9.2) it has been inferred by Haase et al. (2007) that this eruption may coincide with the record of a major seismic crisis in the area from 25 to 26 June 2002. Hence, this lava flow may represent one of the few occasions in submarine volcanological studies where the age of formation for a particular lava unit is actually known. Therefore, one half of a ROV dive (station ATA-46ROV) was devoted to the task of determining the dimensions and structures of the lava flow and to define its eastern and southern borders. This information shall be used in order to guide future deployments of an AUV (potentially during the next scheduled visit of the area in 2009) for locating the eruptive vent and areal extent of this flow unit.

Dive ATA-46ROV was successful in locating the eastern, strongly serrated contact of the 2002 (?) flow and to the south. Samples from older lava units have been obtained at two locations (ATA-46ROV-2 und -3). In the south, the older sheet lava flow is characterized by the construction of up to 3 m high lava tunnels which are locally collapsed providing evidence that most of these structures are hollow (Fig. 2.4.9.3; collapse structure).

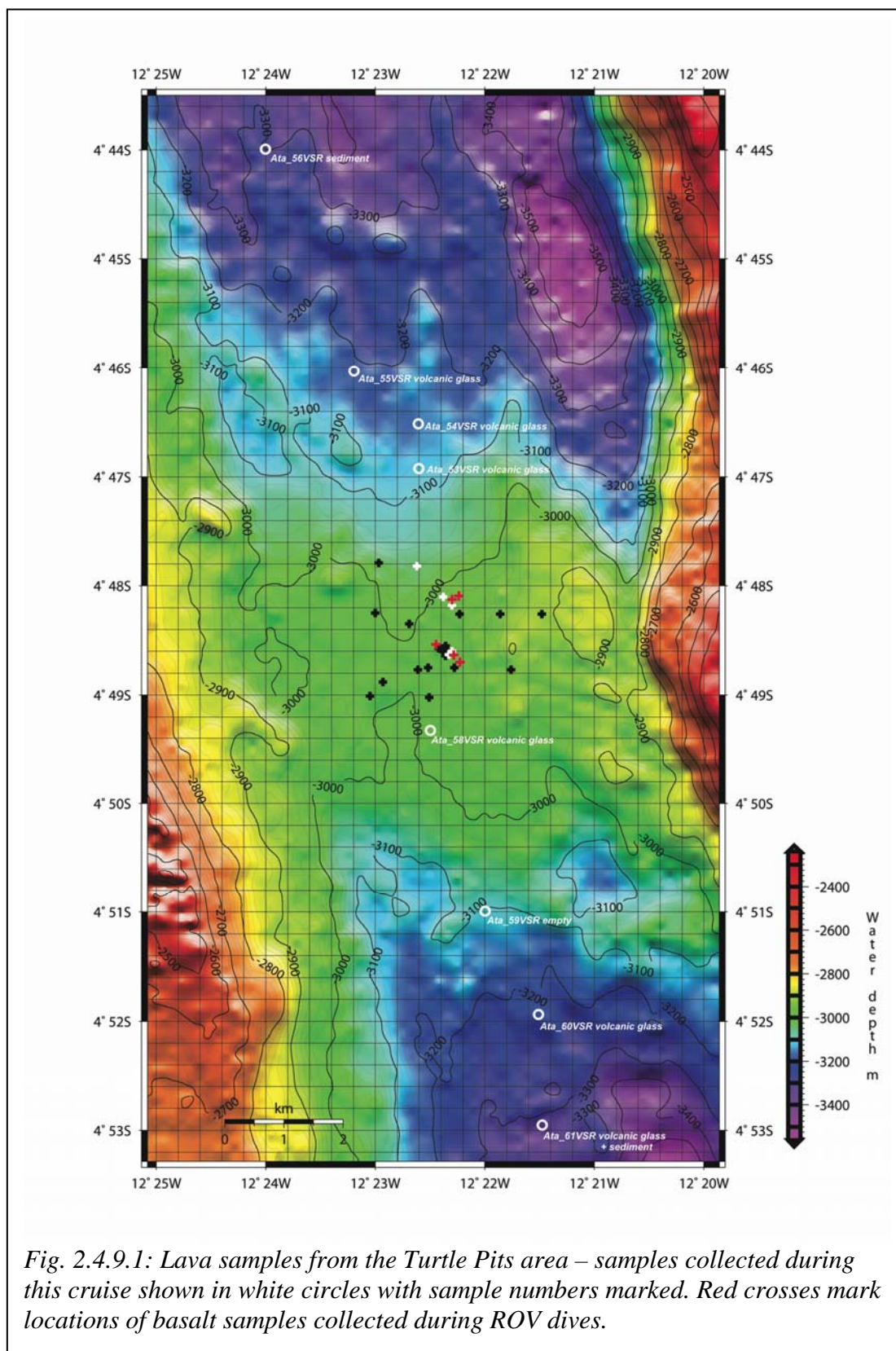
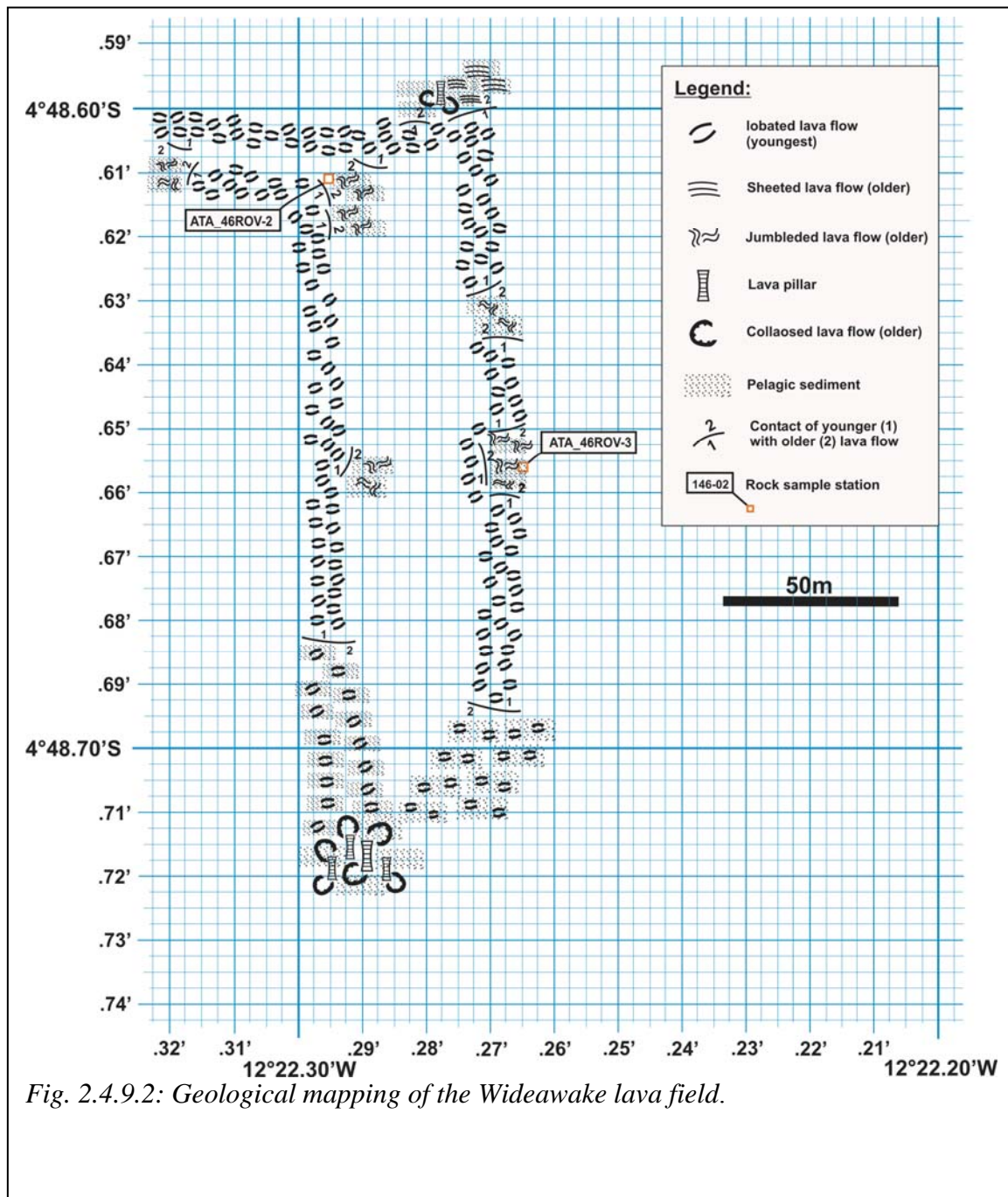

Fig. 2.4.9.1: Lava samples from the Turtle Pits area – samples collected during this cruise shown in white circles with sample numbers marked. Red crosses mark locations of basalt samples collected during ROV dives.

The lava flowing through these systems was apparently well insulated from cooling and discharged at the flow front when magma supply ceased. Such eruption processes are a common phenomenon at subaerial lava fields with high eruption rates of low viscosity-high

temperature basalt lavas such as Hawaii. Clearly, recognition of such processes is important if erupted volumes are to be determined.



As an additional complication, we recognized that the young, 2002 (?) flow is locally channelled into the pre-existing lava drainage system provided by the sheet flow lava tubes. Hence, some portion of that eruption may have been emplaced below the seafloor, escaping seafloor mapping efforts.



Fig. 2.4.9.3: Young lava flow (left) in old collapsed "hall"

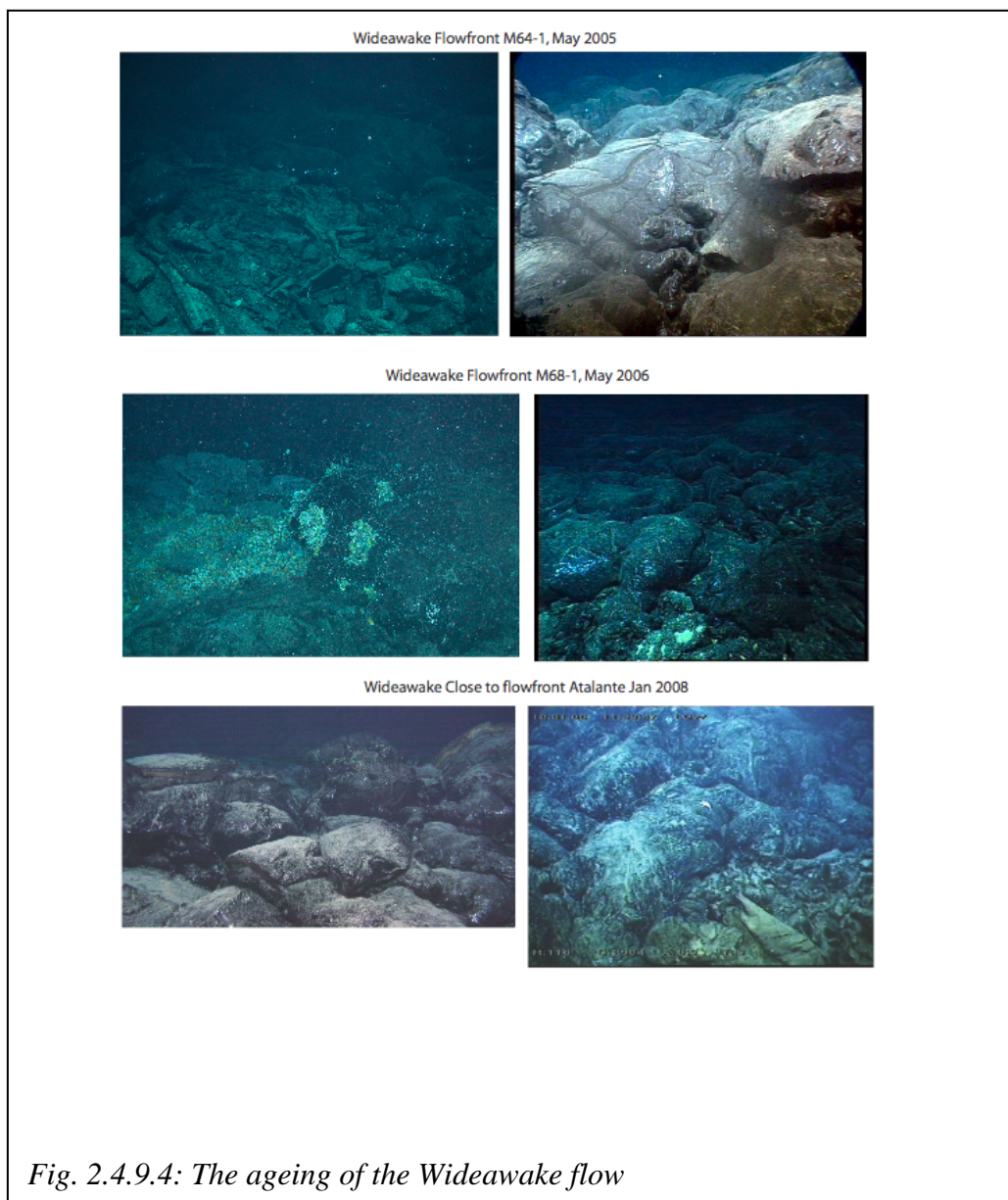

Furthermore, we recognized some signs of „aging“ of the 2002 (?) lava flow. Comparing the seafloor images obtained in 2005, 2006 and during this cruise, we observed that the „glassy luster“ of the flow surface (described by Haase et al., 2007) is apparently waning (Fig. 2.4.9.4). This could be inferred to be due to progressive incipient alteration of the upper surface of the quenched basalt glass covering the lava lobes. Also, we encountered a site of low T (up to 10 °C) fluid discharge on the 2002 (?) lava flow itself. Fluid discharge (shimmering water) is concentrated in lava lobe interstices and the site is colonized by abundant small mussels colonizing cracks of the lava surface. These observational similarities to the Lilliput hydrothermal site (located at ~9°30'S), discovered during cruise M64-1, are astonishing. For both sites, recent initiation of hydrothermal discharge and colonization by mussels may be inferred. Potentially, the 2002 (?) lava flow may have covered a pre-existing hydrothermal discharge site and hydrothermal fluid ascent through this flow has now been established.

Comfortless Cove hydrothermal area

The ROV dives to this hydrothermally active area, located approximately 2 km to the NNE of Turtle Pits were mainly focussed on obtaining fluid and biological samples. However, it has been possible to add observational data and basalt samples to the material collected during cruise M68-1. The basalt pillow mound located to the north of the Sisters Peak black smoker chimney was sampled (ATA-42ROV-16). This pillow flow overlies the older sheet flow that the Sisters Peak smoker is situated on (sample of this sheet flow was obtained during the previous cruise: M68-1_20ROV-3B). In addition, a following dive (station 52ROV) provided spectacular insight into an eruptive fissure located on top of the pillow mound (to the east of sampling site ATA-42ROV-16). The walls of this fissure show remarkable lava flow features in cross section such as sheet flow tops and elongated tubes. In this zone, shells of dead mussels were abundant. At the southern margin of the fissure, patches of living mussels were located and sampled. From this area a basalt sample was also obtained (ATA-52ROV-12).

2.4.10 Rocks from the deeper crust

(Günter Suhr, Jürgen Koepcke)

Three ROV dives were devoted to map and sample the deeper oceanic crust around 5°S. Two dives investigated the “Inside Corner High” at 5°06'S and 11°40'W, one dive was spent at the transform wall opposing the nodal deep at 4°56'S and 11°37'W (Fig. 2.4.10.1). Each dive required about 1000 m of ROV climbing.

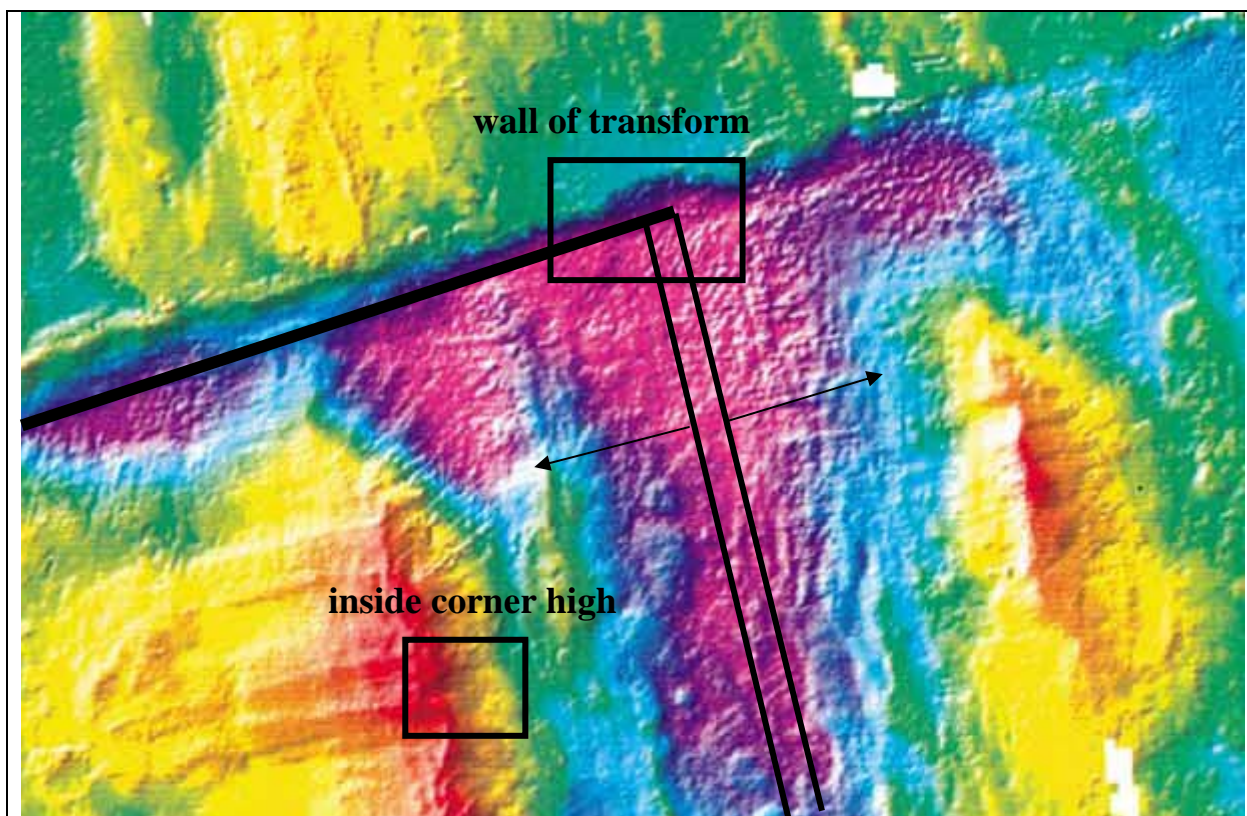

Fig. 2.4.10.1: Shaded relief map of seafloor topography in the 5°S region (Reston et al., 2002). The two areas of interest are marked by rectangles, the (new) ridge axis by a double line, and the transform fault by a thick black line. Massif to east of the ridge axis is the eastern part of the inside corner high, rifted away by the new ridge axis.

Inside corner highs are elevated plateaus with a curved surface at the intersection of a transform fault and an ocean ridge. Experience has shown that they preferentially expose unfaulted lower crustal rocks (Dick et al., 2000; Ildefonse et al., 2007), thus the common term “core complex”. Our current understanding of how these rocks are exhumed is by long-term focusing of strain into a single normal fault associated with internal rotation of the block of up to 90° degrees (Lavie et al., 1999, Fig. 2.4.10.2).

The strain focusing is favored by the occurrence of volumetrically minor, rheologically weak, serpentinized mantle rocks between an otherwise gabbroic crust (Reston et al., 2002; Escartin et al., 2003; Ildefonse et al., 2007). As a result, the inside corner highs tend to have a thin cover of altered and sheared mantle rocks around a gabbroic core. Normally, the rocks inside the core would only be accessible by drilling. However, in case of the occurrence at 5°S, a westward-directed ridge-jump of the eastern ridge axis of the ridge-transform system has rifted apart the core complex, giving access to its internal setup.

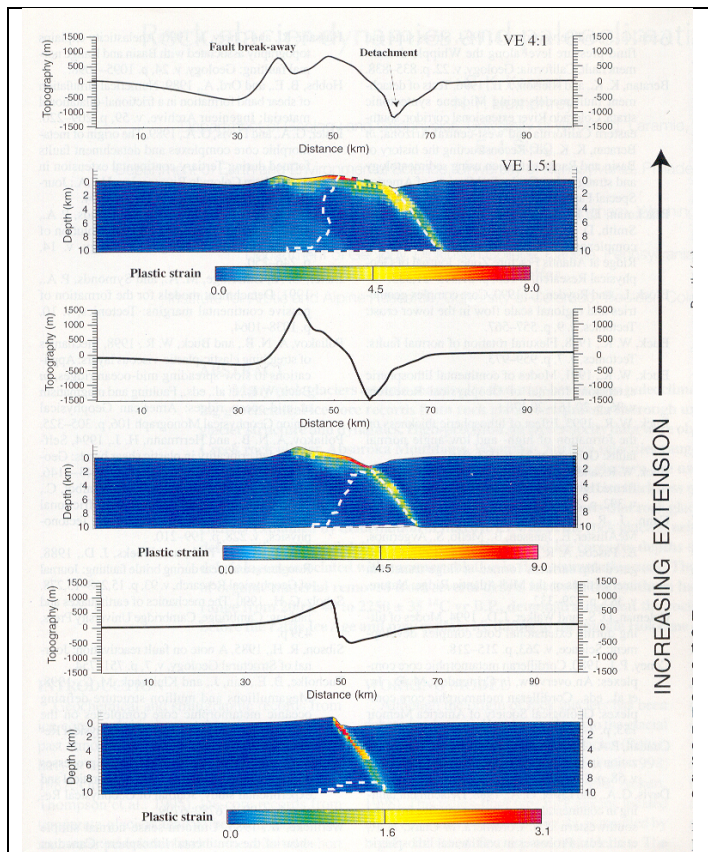

Fig. 2.4.10.2: Numerical model simulating the formation of inside corner highs. Note how an original horizontal marker rotates in an anti-clockwise fashion during exhumation (Lavrier et al., 1999).

We decided to explore the western rift flank of the dissected core complex with the ROV, since the eastern flank would perhaps expose a cross-section parallel to igneous units (Fig. 2.4.10.3). The targets for the dives were thus: (1) is the lithology along the rift flank as expected, i.e. deep rift volcanics, followed by gabbros, capped by sheared peridotite? And (2), can we see expressions of the rift tectonics?

The plan to investigate the northern wall of the transform was a consequence of the requirement to undertake a deep dive to test the ability of the ROV in the 5-6000 mbsf range. This was feasible in the basin forming at the intersection of the ridge axis with the transform fault ("nodal basin", the origin of which is actually poorly understood). The transform wall to the north of it was expected to expose rocks formed at the inside corner of the

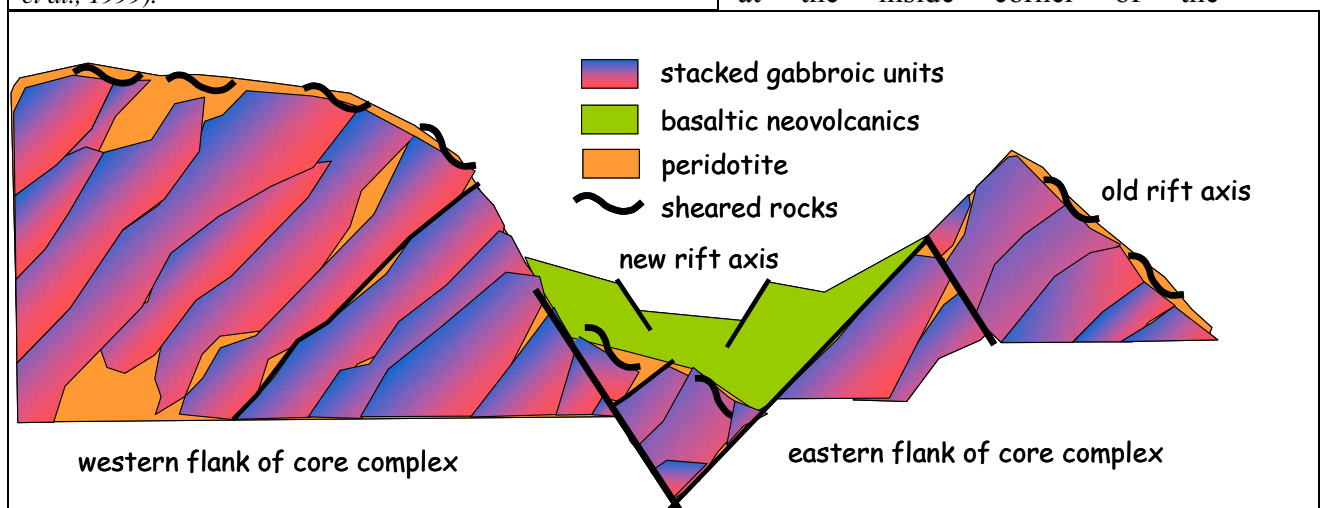

Fig. 2.4.10.3: Pre-dive model of the core-complex at 5°S. Note how the rift of the new ridge is thought to dissect the core complex which would presumably be enveloped by a thin veneer of sheared mantle rocks.

intersection of the northwestern ridge axis with the transform. This lithosphere has drifted with a half-spreading rate of 1.6 cm/year to the east and the rocks located at the northern extension of the south-eastern ridge axis should be ca. 5 Ma old. Since magmatism is thought to decrease (Cannat 1996) near the terminations of first-order segments as defined by transform faults (MacDonald et al., 1988), the questions for this day of the dive were (1) would the transform wall expose mantle rocks reflecting a low magmatic budget or volcanics reflecting abundant magmatism and (2) what is the expression of the transform tectonics?

Practical experience gained during the dives

The first two days of diving went without technical problems though conditions must be considered challenging. Lateral traversing meant that the ship had to follow the ROV with an equivalent speed, the covered vertical distance implied an on-going operation of the winch to haul in cable. Cliffs, corners, and huge boulders presented a danger for the cable to get caught. The group agreed that alternative sampling of this slope by dredging methods would be extremely hazardous since the dredge-container could easily be caught and ripped off. On the deep-dive test, the Orion arm behaved erratic.

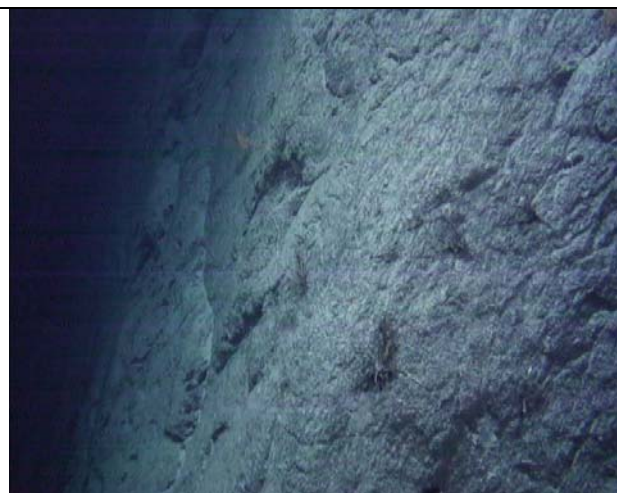

Fig. 2.4.10.4: Cliff face in gabbro with true dip of $\sim 75^\circ$ on Inside-Corner High traverse. Visible height estimated 2, in, distance 10 m. Parking the ROV and take a sample? No easy task!

On the first day we took seven, on the second day fifteen, on the third day fourteen samples, usually using the Orion-arm, but exceptionally also the Rigmaster arm. Dislodging in-situ samples turned out to be nearly impossible, so we mostly collected samples which were already loose. In most cases, we could convince ourselves that they were locally derived. Parking the ROV at the often near-vertical cliff-faces was extremely challenging and in several cases our pilots had to grab samples “on the fly”. Samples were stored away in any of the four drawer compartment or – in the case of big samples – on the “porch” at the front of the ROV. Untangling some fifteen similar-looking samples required a strict book

keeping during sampling and more smaller instead of few larger compartment might have been preferable for our purposes.



Fig. 2.4.10.5: The ROV drawer, configured for – and filled with – rocks. Bookkeeping required! Additional tools from left: IB sampler, shovel, bionet.

It turned out nearly impossible to discriminate different lithologies by direct observations during our dives, since nearly all rocks were covered by Mn-crusts. We thus had to use morphological features and later calibrate our mapping with the samples taken. Here, the monitoring of the dive by video and HD cameras turned out to be very useful. Measuring the orientation of the structural elements like cliffs, joints, faults, laminations, corrugations on surfaces and suspected dyke contacts was feasible thanks to the known heading of the ROV. The on-board sonar was of great help in finding and measuring the orientation of interesting

elements. It showed reliably boulders in sediments and cliffs with their orientation at distances far beyond the area illuminated by the search lights. The available topographic seafloor maps were not accurate enough for planing the route during our dives though we always used them as a rough guide. Some features of the maps turned out to be relevant, others were only artifacts. In the end, we agreed that the visual information and geographic

coordinates (for us, mainly depth) associated with our samples will be of invaluable help in interpreting the data.

Geological Results of the Inside Corner High Dives

The two-day traverse covered the depths from 3400 to 1500 mbsf. The base of western rift flank was heavily sediment (Fig. 2.4.10.6). We could only collect one boulder sample which turned out to be a peridotite breccia, ultimately perhaps derived from the very top of the plateau.

As we headed westward, the slope steepened and cliffs appeared which strike between 300 and 340° and typically dip 70° to the E to NE. The major wall of the rift is a shear cliff of some 200m vertical distance, starting at 2500 mbsf (Fig. 2.4.10.4).

We could identify downdip slickensides, consistent with rift-related faulting (Fig. 2.4.10.7).

The orientation of the major cliff face, interpreted as the master rift fault, was repeatedly measured and is not quite understood since it is at an angle of some 10°-50° to the current ridge axis (trending 350°). In more detail, the rift-flank consists of ridges and valleys, the latter ones probably originating in transverse faults. The valleys tended to be full of talus in a matrix of foraminiferous ooze so that we preferred to ascend along the ridges. A single, doubtful observation of igneous banding on a E-W trending cliff face showed the banding dipping 30° to the west, i.e. towards the core complex.



Fig. 2.4.10.8: View in plane polarized light of an entire thin section (3 cm long) showing olivine gabbro-norite. Sample D2-S12 from the 5°S core complex.

Samples taken along the rift flank are mainly gabbros with a subordinate group of microgabbros and dolerite in the upper part (63ROV-9 to 63ROV-11 at 1767 m, 1674 m, and 1636 m). The gabbros range from melanocratic to leucogabbroic. Noritic gabbros are strongly suspected by inspection of hand-specimens. Olivine was not positively identified but is present in one of the samples taking from the *Meteor* cruise M47/2 during dredging



Fig. 2.4.10.6 (top): View of seafloor at the base of the rift flank: large boulders (~ 1 m) in carbonaceous ooze.

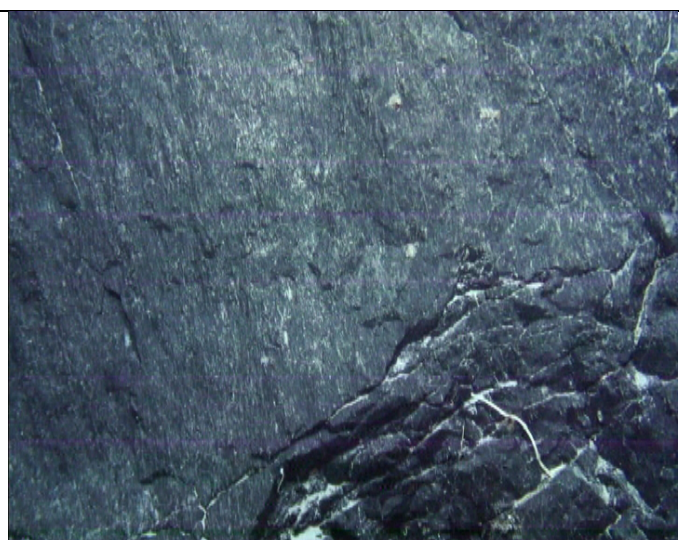

Fig. 2.4.10.7 (right): Slickensides on fault plane indicating down-thrown frontal block.

(Fig. 2.4.10.8). The gabbros are usually medium-grained, one sample is coarse-grained. Felsic netveining is relatively widespread, a vague argument for a closed system evolution (see rock sample photos in Appendix). Oxide gabbros, on the other hand, also representing advanced stages of differentiation only reached in nearly closed systems, were not recovered. Magmatic strain was not observed, suggesting that the gabbro body cooled in the lithosphere. Plastic strain, probably mylonitic, was observed in two samples (50ROV-3 and 63ROV-14). Both appear peridotitic.

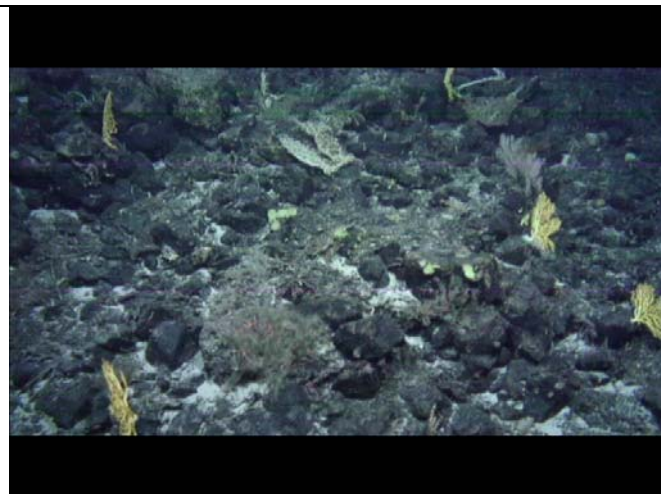

Fig. 2.4.10.9: Top of the Inside Corner High. Sampling confirmed that this is a coral-grown peridotite breccia horizon (ATA-63ROV-13 and -15).



Fig. 2.4.10.10: Highly sheared block of (ultramylonitic?) peridotite (?) 50 m beneath the plateau (ATA 63ROV-14)

Our impression is that the samples show a certain degree of greenschist-grade alteration. This is somewhat surprising, since the usually internally unfaulted nature of core complexes would make the penetration of water difficult.

The transition from the rift flank to the top of the plateau was abrupt. We traversed this edge twice to confirm the observation. Two samples taken at the top very near the edge turned out to be peridotite breccias (Fig. 2.4.10.9) whereas this breccia is absent all along the rift flank. A highly interesting, in-situ sample was recovered just beneath the plateau (ATA-63ROV-14): the dense, laminated rock appears to be ultramylonitic, probably peridotitic and may represent an early, higher temperature stage of the detachment fault (Fig. 2.4.10.10). Its orientation is moderately dipping to the NE. In total, all deformed samples (breccias and mylonites) are probably peridotitic. This strongly supports the current model of peridotite-related strain softening of the master normal fault. A cross-section and map of the traversed terrane is shown in Figs. 2.4.10.11 and 2.4.10.12, respectively.

About 32 hours video material taken with three cameras were cut to a condensed version of 20 minutes showing the main geological and morphological features.

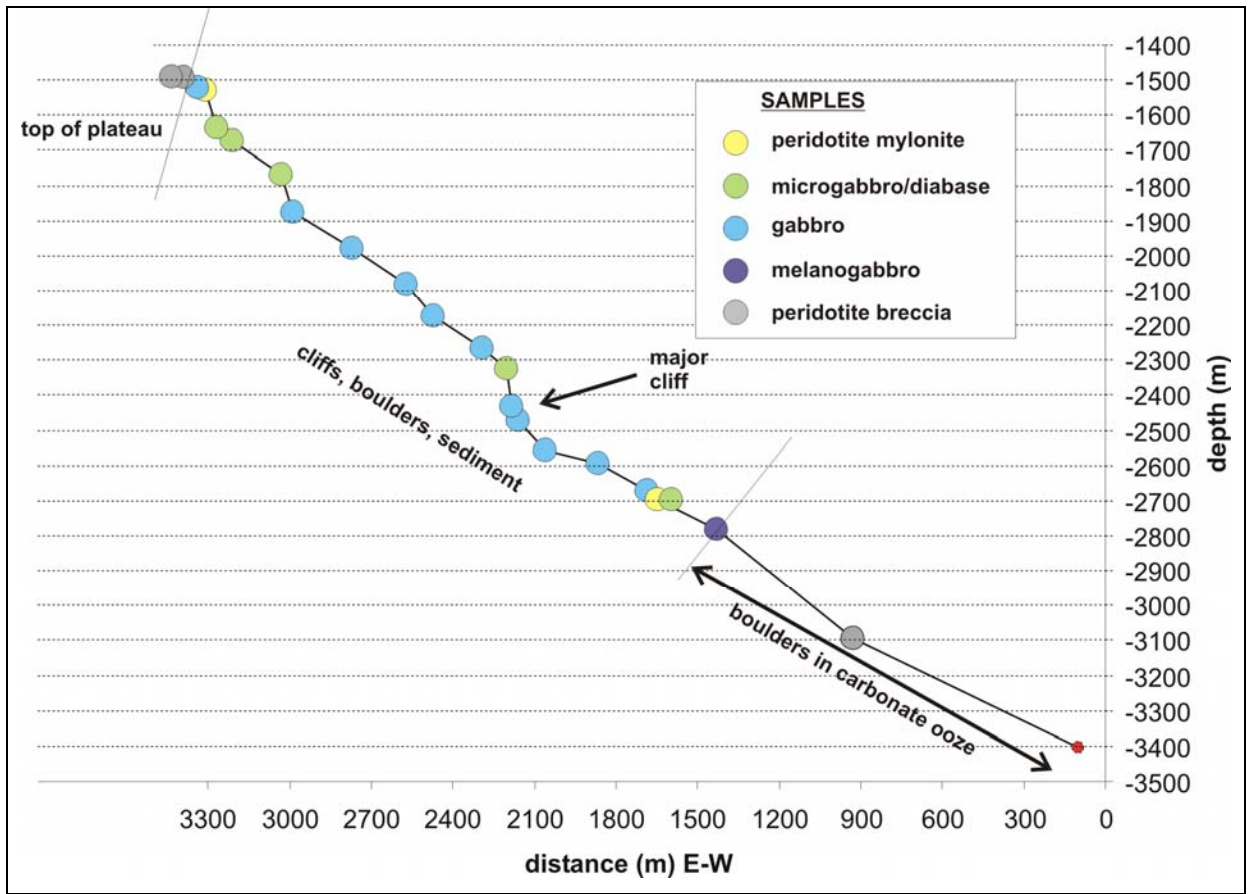

Fig. 2.4.10.11: Inside Corner High traverse projected onto an E-W profile. Sample locations are shown.

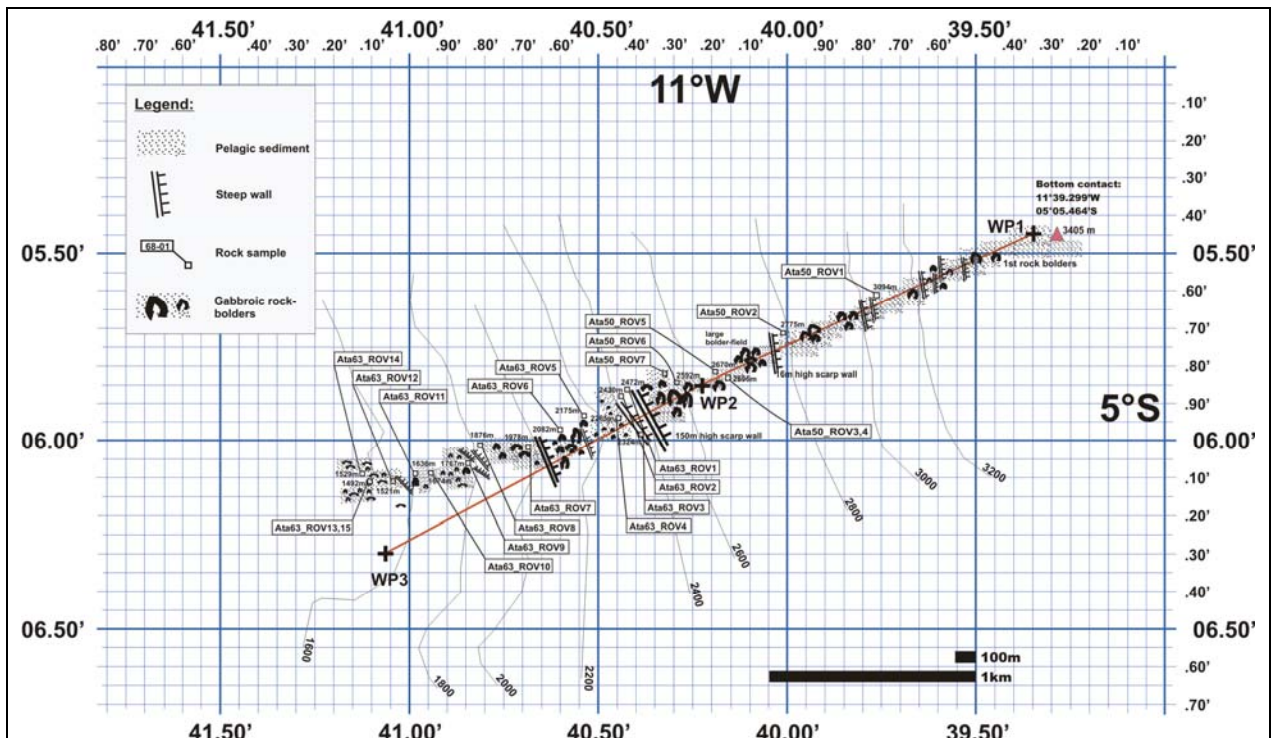

Fig. 2.4.10.12: Outcrop map of the two day traverse up the inside corner high.

Geological Results of the Transform Fault Dive

The topographic overview Fig. 2.4.10.1 shows that the new south-eastern ridge axis has also affected the opposing transform wall, since the latter shows a marked topographic depression where the continuation of the ridge axis intersects the transform wall. During our dive, however, there was a clear predominance of E-W trending cliff faces in the transform wall which we logically attribute to strike slip faulting associated with transform tectonics.

An impression of both the inside corner high and transform traverses are the striking similarity of continental and submarine landscapes. Near vertical cliff faces, talus slopes, *Felsenmeere* (Fig. 2.4.10.13) and slopes with rugged ridges and sediment-filled valleys were all recurring views familiar from land. Particularly the transform transect showed abundant evidence for mass-wasting. Perhaps the major difference to continental landscapes are the valley floors filled smoothly with sedimented, hosting groups of sticking out, large boulders as well as slopes which appeared generally to be somewhat steeper than on land (because of the reduced gravitational force available for collapse?).

During the dive itself, we were convinced that in the lower part, serpentinite and gabbro is exposed. However, ground truthing via sampling showed that the entire traverse was within diabase and microgabbro which we crossed in east-west trending ridges with intervening shallower, more sedimented parts perhaps related to faulting. We thus covered about 1000 vertical meters of upper oceanic crust with the likely addition of another 300 m above the point where we had to abandon the traverse due to time constraints. Thus,

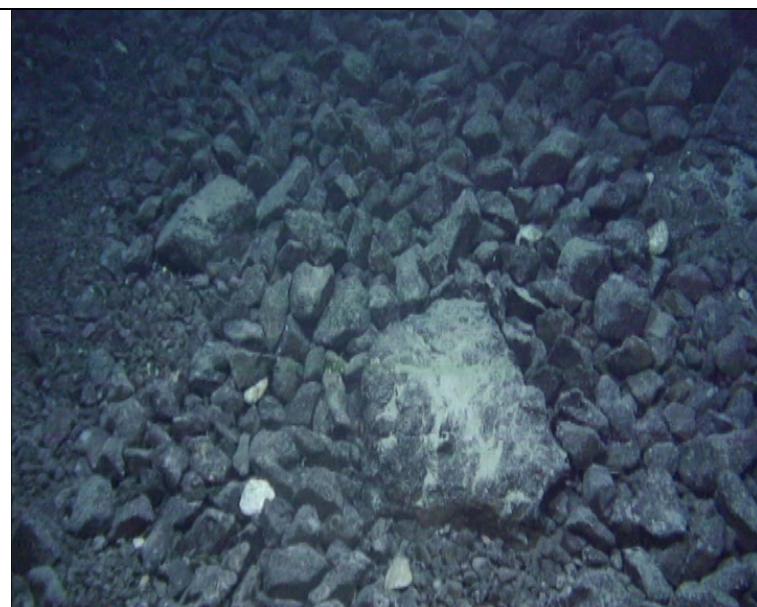

Fig. 2.4.10.13: *Felsenmeer*, presumably collecting rocks from the dyke complex.

the upper crust in this region is likely to be fully developed with some 1.5 km of volcanics and subvolcanics. A so-called “transform effect” with a reduced or even absent crust seems very unlikely. Our contrasting traverses up the inside corner high and the transform wall emphasized the uniqueness of core complexes in giving easy access to lower crustal rocks.

In several locations, there is strong evidence for an exposure of sheeted dykes (Fig. 2.4.10.14). Consistently, the locally sampled rocks are diabases, representing rapid cooling but no contact to seawater. We may even have collected one chilled margin sample (70ROV-7). Joints developed in the sheeted dyke complex during cooling give a characteristic, faceted outcrop picture but a dominating joints system represents the dyke contacts. Based on our observations, it seems likely that the entire cliff between 4380 and 4050 m is mainly made out of sheeted dykes. The dykes appear to have a predominant jointing dipping 70° to the west, interpreted as dyke-dyke contacts. This would translate to an inward rotation of an assumed original vertically oriented dyke swarm at the western ridge. There was no evidence for felsic veining as would be typical for the sheeted dyke – gabbro transition. Nor did we see pillow lavas which would represent the near sea-floor environment.

The degree of hydrothermal alteration can only be safely determined petrographically but hand-specimen inspection suggests that it is pervasively present. An excellent opportunity will offer itself by comparing our section to IODP Hole 1256D which recently covered 1.5 km of upper oceanic, fast-spreading crust by drilling (Koepke et al., submitted) as well as to the famous ODP Hole 504B.

The trend of the dykes appears to be – as it should – normal to the transform and the cliff faces. What would then form the E-W

trending, steeply south dipping cliffs? In some cases we found good evidence for exposed shear planes with, in one case striations on such a face with a 25° eastern pitch (several attempts to sample this rock failed) (Fig. 2.4.10.15). Assuming a dextral shear as derived

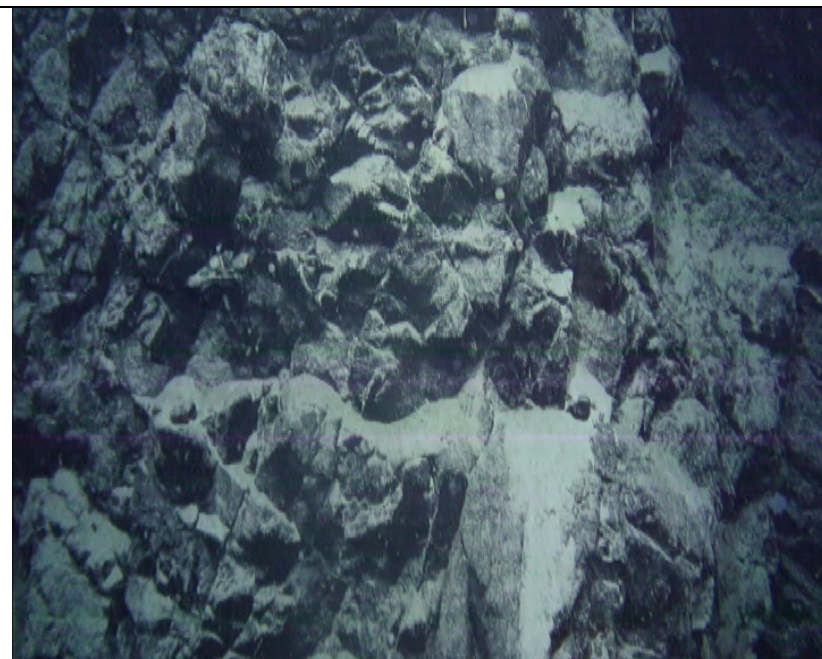

Fig. 2.4.10.14. View of sheeted dykes with dominant joint-system dipping 75° to the left (west). Looking north at 4300 mbsf.

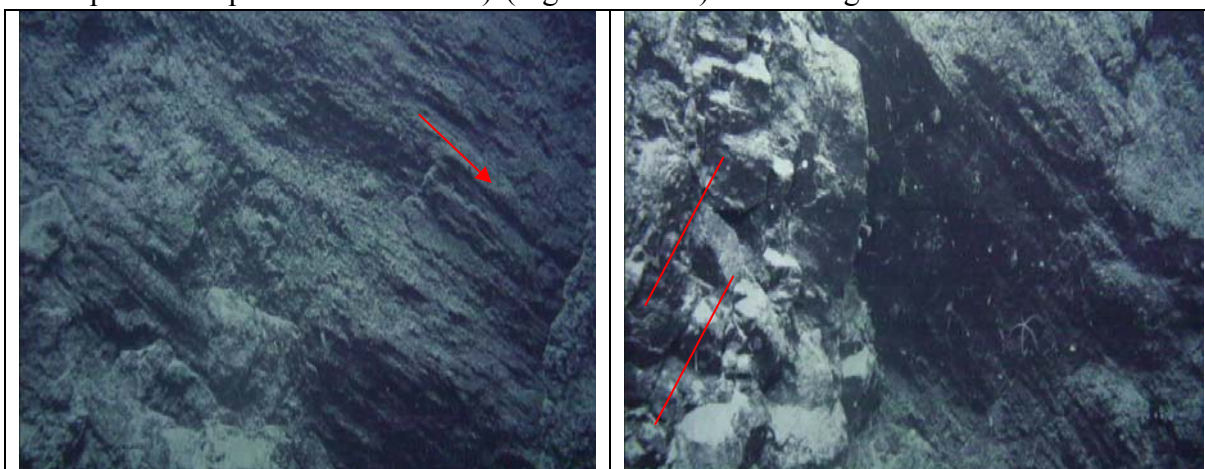

Fig. 2.4.10.15: At the left, a steeply south (towards viewer) dipping fault surface with striations (arrow) is shown (4350 mbsf.). Photo at right shows same feature in the geological context: the fault plane occurs as a wall behind a dyke complex which strikes at high angle to it and with contacts dipping steeply to the left (west, red lines)

from the overall transform movement, this would mean a thrust component on the transverse movement, i.e. the southern block appears to have moved obliquely up and west with respect to the northern block (moving obliquely down and east). Higher up in the profile, at 4000 mbsf, a fault plane dipping 40° to the south was observed. Note that in this upper part, the topography is also shallower. We speculate that most of the near-vertical cliff are the expression of a late, brittle transverse fault.

The highest section covered with the ROV has a markedly different appearance. The dominant jointing system is absent, the rocks show a small-scale, intensely fractured surface, and a dominant structural grain may represent flow planes (Fig. 2.4.10.16). A working model calls here for massive flows.



Fig. 2.4.10.16: Near the upper end of the profile, intensely jointed rocks with a locally visible structural grain (here from top right to bottom left) became dominant. Our working model calls for an origin as massive flows.

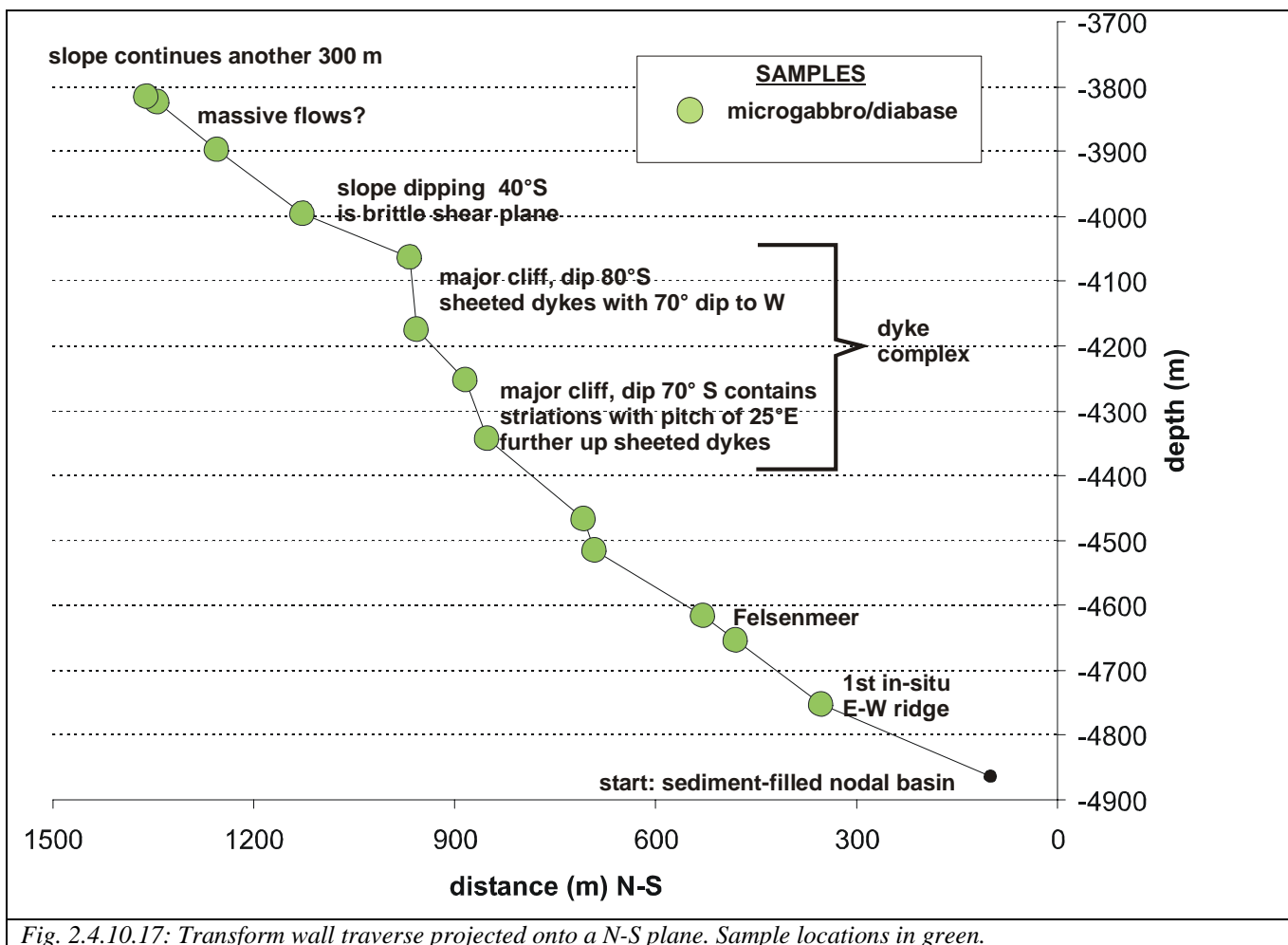

Fig. 2.4.10.17: Transform wall traverse projected onto a N-S plane. Sample locations in green.

2.4.11 ROV deployments during MAR SOUTH IV

(K. Lackschewitz, D. Comany, A. Foster, C. Hinz, E. Labahn, A. Meier, M. Pieper, J. Schneider)

Leg 2 of RV ATALANTE is the second scientific cruise of the Kiel ROV 6000 within the priority program 1144 „From mantle to ocean“. A detailed technical description and operation of the entire system is given in the „chapter 1.4.10“ of the Leg 1 cruise report „HYDROMAR V“.

Table 2.4.11.1: Summary of ROV dives during MAR SOUTH IV

ATA-Leg 2 Station #	IFM-GEOM AR Dive #	Date	Site	Depth (m)	Time Launch	Time (UTC) Start (Bottom)	Time (UTC) End (Bottom)	Time (UTC) on Deck	Bottom Time	Total Dive Time
35ROV	13	14.0 1.08	Turtle Pits	2988	09:39	11:13	17:40	18:55	06:27	09:16
37ROV	14	15.0 1.08	Wideawake/	3000	09:39	11:12	16:50	18:15	05:38	08:36
42ROV	15	16.0 1.08	Comfortless Cove	3000	09:20	10:48	18:08	19:24	07:20	10:04
46ROV	16	18.0 1.08	Turtle Pits/ Wideawake	3000	09:25	11:10	17:58	19:15	06:48	09:50
50ROV	17	19.0 1.08	Inside Corner High 5°S	3095	09:40	11:29	17:32	18:43	06:03	09:03
52ROV	18	20.0 1.08	Comfortless Cove	2990	10:00	11:43	17:20	18:39	05:37	8:39
57ROV	19	21.0 1.08	Turtle Pits	2990	09:36	11:03	19:29	20:50	08:26	11:14
63ROV	20	23.0 1.08	Inside Corner High 5°S	2000	08:50	10:34	17:32	18:29	06:58	9:39
67ROV	21	24.0 1.08	Red Lion	2960	09:20	11:42	15:19	16:26	03:37	7:06
68ROV	22	24.0 1.08	400m NW of Comfortless Cove	3000	17:17	18:33	21:36	22:45	03:03	5:28
70ROV	23	25.0 1.08	Ascension Fracture Zone	4890	10:45	13:04	22:32	00:06	09:28	13:21

The technical innovations of the ROV provided a flexible and highly adaptable platform for scientific sampling and observation tasks and therefore played a major role for the scientific success aboard RV ATALANTE. Since the previous leg we have additionally installed a rotary sampler with a slurp gun.

In total 11 dives were carried out on 13 working days on the southern Mid Atlantic Ridge at 5°S. A summary about the statistics of the ROV dives are presented in Tab. 2.4.11.1. Launch and recovery has been done at sea states < 2m and winds < 4 bft.

Total dive times of 102 h including almost 70 h bottom time could be achieved at depths of 3000m. During our last dive ROV Kiel 6000 was deployed for the first time to a depth of 4890 m which is also the deepest dive for a ROV manufactured by Schilling Robotics.

The following scientific tools and devices were used on “KIEL ROV 6000m” during the above mentioned dives for obtaining biological, petrological and fluid-geochemical samples:

- KIPS fluid sampling system (incl. high-temperature sensor)
- Ti-Majors fluid sampler
- Isobaric gas sampler
- He tube
- 8-channel low-temperature lance
- SMONI (1-channel high temperature logger)
- Nets for biological sampling
- Slurp gun with rotary sampler

Three colour video cameras (1 HDTV and 2 Standard PAL cameras) have produced a large amount of video data. Videos from the standard cameras were permanently and synchronously recorded as mpeg2 files to a video server. HDTV videos were recorded only at scientific request. They are stored in HD format on a MacintoshPro and as mpeg2 files on the same video server as the standard videos. Approximately one hour of HDTV video was stored per dive. The video data stored on the video server is available to all scientists in SD converted format via the vessel's intranet using a web browser. The so-called Proxsys™ software on the server enables video previews (as mpeg4), cut and download of selected video sequences (as mpeg2).

Unfortunately, the digital still camera did not work after we had changed the defect controller board with a new board provided by the manufacturer.

After some problems during Leg 1, the Posodonia USBL navigation worked well. However, due to a malfunction of the Posidonia system it could not be used for dive 18 (station ATA-52ROV). In addition, at the beginning of our station work two homer beacons were set on the seafloor at Turtle Pits and Wideawake as reference positioning stations. Both were collected at the end of our dive operation in these areas.

2.5 Acknowledgements

The scientists of Atalante Leg 2 would like to thank Capt. Glehen and his crew for superb support at sea. The flexibility of the Senatskommission für Ozeanographie, the Deutsche Forschungsgemeinschaft and the Leitstelle Meteor/Merian in making these cruises possible in the short time available is gratefully acknowledged.

2.6 References

- Baines, A.G., Cheadle, M. J. et al. (2003). Mechanism for generating the anomalous uplift of oceanic core complexes: Atlantis Bank, southwest Indian Ridge. *Geology* 31, 1105-1108
- Caldeira, K. and Wickett, M.E. (2003). Anthropogenic carbon and ocean pH. *Nature*, 425:365
- Cann, J.R.; Blackman, D.K.; Smith, D.K.; McAllister, E.; Janssen, B.J.R.; Mello, S.; Avgerinos, E.; Pascoe, A.R.; Escartin, J. (1997). Corrugated slip surfaces formed at ridge-transform intersections on the Mid-Atlantic Ridge, *Nature*, 385, 329-332.
- Cannat, M. (1996). How thick is the magmatic crust at slow spreading oceanic ridges? *Journal of Geophysical Research* 101, 2847-2857.
- Cannat et al. (1995). An ultramafic rift at the Mid-Atlantic Ridge: successive stages of magmatism in serpentinized peridotites from the 15°N region, in: R.L.M. Vissers, A. Nicolas (Eds.), *Mantle and lower crust exposed in oceanic ridges and in ophiolites*, Kluwer, Dordrecht, 5-34.
- Cannat et al. (1992). Serpentinized peridotites and gabbros in the Mid Atlantic Ridge axial valley at 15°37'N and 16°52'N. *Earth Planet. Sci. Lett.* 109 (1992), 87–106.
- Damm et al. (1985). Chemistry of submarine hydrothermal solutions at 21°N, East Pacific Rise. *Geochimica et Cosmochimica Acta* 49 (11), 2197-2220.
- Dick, H. J. B., J. H. Natland, et al. (2000). A long in-situ section of the Lower Ocean Crust: results of ODP Leg 176 Drilling at the Southwest Indian Ridge. *Earth and Planetary Sciences Letters* 179, 31-51.
- Douville et al. (2002). The Rainbow vent fluids (36° 14'N, MAR): the influence of ultramafic rocks and phase separation on trace metal content in Mid-Atlantic Ridge hydrothermal fluids. *Chemical Geology* 184, 37-48.
- Escartin, J., C. Mével, et al. (2003). Constraints on deformation conditions and the origin of oceanic detachments: The Mid-Atlantic Ridge core complex at 15_45°N. *Geochemistry, Geophysics, Geosystems* 4 (1067, doi:10.1029/2002GC000472).
- Fahey, R.C. and Newton, G.L. (1987). Determination of low-molecular-weight thiols using monobromobimane fluorescent labeling and high-performance liquid chromatography. *Methods Enzymol*, 143, 85-96.
- Garbe-Schönberg et al. (2006). KIPS – A new multiport valve-based all-teflon fluid sampling system for ROVs. EGU General Assembly, Vienna, April 2006.
- Grasshoff (1999). *Methods of Seawater Analysis*. 3rd edition, 600 p., Wiley-VCH
- Haase et al. (2007). Young volcanism and related hydrothermal activity at 5°S on the slow-spreading southern Mid-Atlantic Ridge. *G³*, 8 (11).
- Ildfonse, B., D. K. Blackman, et al. (2007). Oceanic core complexes and crustal accretion at slow spreading ridges. *Geology* 35, 623-626.
- Kelley, D.S., Karson, J.A., Blackman, D.K., Fruh-Green, G.L., Butterfield, D.A., Lilley, M.D., Olson, E.J., Schrenk, M.O., Roe, K.K., Lebon, G.T. the AT3–60 Shipboard Party and Rivizzigno, P. (2001). An off-axis hydrothermal vent field near the Mid-Atlantic Ridge at 30°N. *Nature* 412, 145–149.

- Klein, E. M., & Langmuir, C. H. (1987). Global correlations of ocean ridge basalt chemistry with axial depth and crustal thickness, *J. Geophys. Res.*, 92, 8089-8115.
- Koepke J, Christie DM, et al. (2007 submitted). Petrography of the Dike/Gabbro Transition at IODP Site 1256D (Equatorial Pacific): The evolution of the Granoblastic Dikes. *Geochem Geophys Geosyst.*
- Koepke, J., Feig, S.T., Snow, J. (2005). Hydrous partial melting within the lower oceanic crust. *Terra Nova* 17, 286-291.
- Koepke, J., Feig, S.T., Snow, J. (2005). Late-stage magmatic evolution of oceanic gabbros as a result of hydrous partial melting: Evidence from the ODP Leg 153 drilling at the Mid-Atlantic Ridge. *Geochem. Geophys. Geosyst.* 6, no. 2004GC000805.
- Koepke, J., Feig, S.T., Snow, J., Freise, M. (2004). Petrogenesis of oceanic plagiogranites by partial melting of gabbros: An experimental study. *Contrib. Mineral. Petrol.* 146, 414–432.
- Lavier, L. L., W. R. Buck, et al. (1999). Self-consistent rolling-hinge model for the evolution of large-offset low-angle normal faults. *Geology* 27 (12), 1127-1130.
- Macdonald, K. C., P. J. Fox, et al. (1988). A new view of the mid-ocean ridge from the behaviour of ridge-axis discontinuities. *Nature* 335, 217-225.
- Mitchell, J. (Ed.), 2005. The greenhouse effect and climate change – A briefing from the Hadley Centre, 77 pp.; Hadley Centre, Exeter.
- Parmentier, E. M. and J.P. Morgan (1990). Spreading rate dependence of three-dimensional structure in oceanic spreading centers. *Nature*, 348, 325-328.
- Rehder et al. (1999). Methane in the northern Atlantic controlled by microbial oxidation and atmospheric history. *Geophysical Research Letters*, 26 (5), 587-590.
- Reston, T. J., W. Weinrebe, et al. (2002). A rifted inside corner massif on the Mid-Atlantic Ridge at 5°S. *Earth and Planetary Science Letters* 200, 255-269.
- Rethmeier, J., Rabenstein, A., Langer M., Fischer U.(1997). Detection of traces of oxidized and reduced sulfur compounds in small samples by combination of different high-performance liquid chromatography methods. *Journal of Chromatography A*, 760, 295-302.
- Tucholke, B.E., Lin, J. et al. (1998). Megamullions and mullion structure defining oceanic metamorphic core complexes on the Mid-Atlantic Ridge. *J. Geophys. Res.* 103, 9857-9866

Appendix

Appendix 1: Extended list of operations

Appendix 2: Fluid Chemistry results and subsamples

Appendix 3: ROV dive protocols

Appendix 1



Extended list of operations

<i>Extended list of operations</i>		
station (date/time UTC)	instruments used /samples /comments	location
12.01.08		
ATA- 31CTD 17:17:57 – 19:11:30	LADCP, no MAPR, 21 bottles	05°22.396'S, 16°22.917'W @ 4164 m cable out
13.01.08		
ATA- 32CTD 21:57:00 – 23:49:35	LADCP, no MAPR, 16 bottles	04°47.701'S, 12°23.604'W @ 3017 m cable out
14.01.08		
ATA- 33CTD 01:05:33 – 02:58:26	LADCP, 1x MAPR, 21 bottles, 2 not closed, 1 not tight	04°47.422'S, 12°22.603'W @ 3088 m cable out
ATA- 34CTD 04:20:22 – 06:15:35	LADCP, no MAPR, 16 bottles	04°47.103'S, 12°21.635'W @ 3013 m cable out
ATA- 35ROV deployment 09:39 at bottom 11:13	<i>tools: SMoni, ROV-Beacon, 2x He tubes, 2x Titan Majors</i>	<i>ship at</i> 04° 48.5696S, 2°22.4497W
12:13 :22 deployment homer beacon		04°48.583'S, 12°22.414W homer beacon
12:17:50	Site Two Boats	

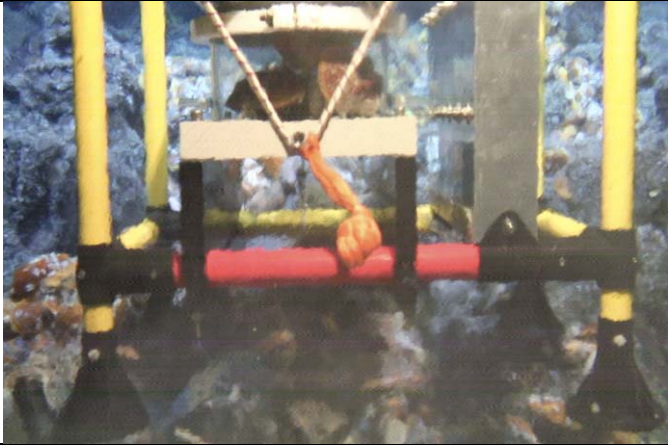
<i>Extended list of operations</i>		
station (date/time UTC)	instruments used /samples /comments	location
	KIPS fluids from hot vent, but bottled turn out to be not filled, thus no pH, chlorinity	
12:49:25	Bottle C9 =35ROV1; T _{KIPS} =406°C pH= Cl=	
12:54:24	Bottle C8 =35ROV2; T _{KIPS} =417°C pH= Cl=	
12:58:59	Bottle C7 =35ROV3; T _{KIPS} =412°C pH= Cl=	
13:04:20	Bottle B6 =35ROV4; T _{KIPS} = pH= Cl=	
13:09:12	Bottle B5 =35ROV5; T _{KIPS} = pH= Cl=	
13:14:14	Bottle B4 =35ROV6; T _{KIPS} =420°C pH= Cl=	
13:47:54	Ti-major bottle D1 = 35ROV7 pH= 6.44 Cl=550	
		Fluid sampling with Ti-majors
14:34:39	Ti-major bottle D2 = 35ROV8 pH=2.92 Cl=360	
14:43:32	SMoni measurement =35ROV9; T _{max} =393°C	
15:06:35	Bottle A3 =35ROV10; T _{KIPS} =451°C pH= Cl=	
15:12:13	Bottle A2 =35ROV11; T _{KIPS} =427°C pH= Cl=	
15:17:03	Bottle A1 =35ROV12; T _{KIPS} =427°C pH= Cl=	
15:31:26	SMoni measurement =35ROV13; T _{max} =396°C	
15:43:01	He-sample =35ROV14 (AA label)	
16:04:24	He-sample =35ROV15 (BB label)	
16:46:27	Sulfide sample 35ROV16	
16:46:27	Slurp gun sample (bottle 1) = 35ROV17	
17:34:00	Slurp gun sample (bottle 2) = 35ROV18	
17:40:09 leaving bottom 18:55 ROV on deck		
ATA- 36CTD 20:00:22 – 07:32:30	LADCP, 1xMAPR, keine Proben, JoJo bis 2600m	04°47.394'S, 12°22.600'W @ 3088 m cable out
15.01.08		
ATA- 37ROV 09:39	tools: ROV-Beacon, 8-channel, T-logger, "die fast", 5 bionets	ship at 04° 48.6186S, 12°22.339W

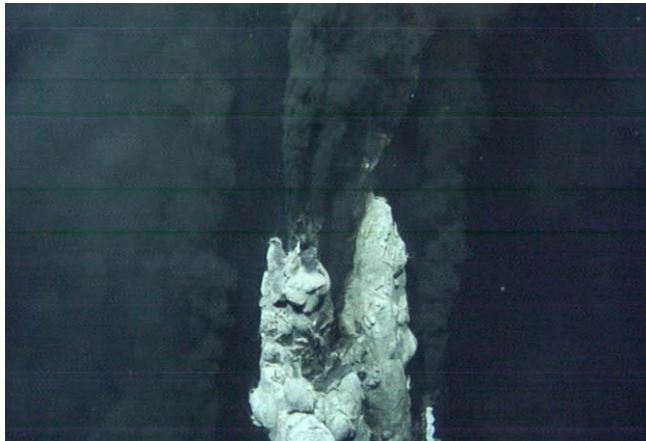
<i>Extended list of operations</i>		
station (date/time UTC)	instruments used /samples /comments	location
<i>deployment</i> 11:12:23 <i>at</i> <i>bottom</i>		
11:31:00 <i>deployment</i> <i>homer</i> <i>beacon</i>		04° 48.626'S, 12° 22.342'W
11:33:25	<i>Site Wideawake</i>	
		KIPS temperature measurement in mussel bed
	KIPS fluids ROV2-5 and ROV10-13 = Diffuse fluids	
11:54:47	Bottle C9 =37ROV1; T _{KIPS} = 7-11° pH=7.5 Cl=560	
11:59:21	Bottle C8 =37ROV2; T _{KIPS} = 4-11° pH=7.05 Cl=550	
12:04:44	Bottle C7 =37ROV3; T _{KIPS} =8-11° pH=7.29 Cl=550	
12:10:45	Bottle B6 =37ROV4; T _{KIPS} = pH=7.03 Cl=560	
12:14:53	Bottle B5 =37ROV5; T _{KIPS} = 12-16° pH= Cl=560	
12:31:05	8-channel T-probe, = 37ROV6, T from 16.7 to 4.4°	
13:49:46	Mussels with net #3; sample 37ROV7	
14:11:07	Slurp gun, bottle 1, sample 37ROV8	
14:48:00	Die-fast instrument is filled 37ROV9	
		“Die-fast” instrument
15:58:16	Bottle B4 =37ROV10; T _{KIPS} =8-9°C pH=7.5 Cl=550	
16:05:02	Bottle A3 =37ROV11; T _{KIPS} =5-7°C pH=7.42 Cl=560	
16:08:57	Bottle A2 =37ROV12; T _{KIPS} =6°C pH=7.39 Cl=550	

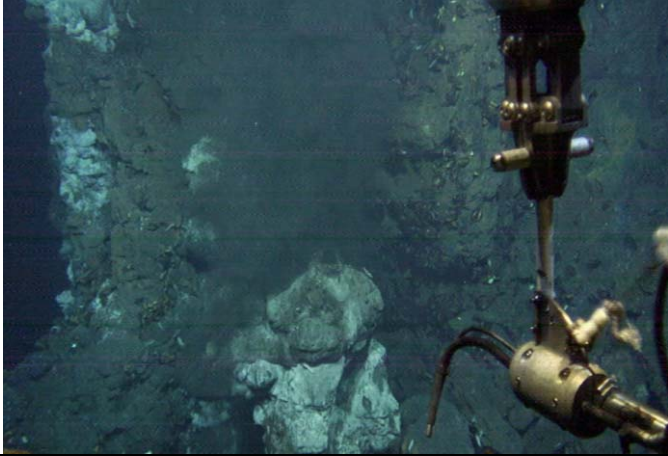

<i>Extended list of operations</i>		
station (date/time UTC)	instruments used /samples /comments	location
16:14:33	Bottle A1 =37ROV13; T _{KIPS} =9°C pH=7.7 Cl=550	
16:29:50	8-channel T-probe, = 37ROV14, 18°C at tip of lance	
16:50:10 <i>off bottom</i> 18:15 <i>ROV on deck</i>		
ATA- 38CTD 19:51:28 – 21:44:58	LADCP, no MAPR, 16 bottles, 1 bottle open	04°44.298'S, 12°20.698'W @ 3082 m cable out
ATA- 39CTD 23:51:30 – 01:51:10	LADCP, no MAPR, 20 bottles, 1 bottle not closed	04°45.147'S, 12°23.002'W @ 3250 m cable out
16.01.08		
ATA- 40CTD 03:07:20 – 04:55:10	LADCP, no MAPR, 16 bottles	04°45.999'S, 12°25.350'W @ 2929 m cable out
ATA- 41CTD 06:06:05 – 07:55:20	LADCP, 1x MAPR, 14 bottles	04°49.197'S, 12°22.199'W @ 2980 m cable out
ATA- 42ROV 9:20 <i>deployment</i> 10:48:04 <i>at bottom</i>	<i>Tools: SMoni, 2 bionets, 1x He tube, 2x Titan Majors, IB-sampler</i>	<i>Ship at</i> 4°48,188'S, 12°22,301'W
	<i>Site: Comfortless Cove</i>	
11:04:43	<i>Found Sister Peak</i> 	<i>ROV at</i> 4°48.222'S, 12°22.270'W Sister Peak
12:43:26	Sample from chimney = 42 ROV-1 KIPS fluids ROV2-5 from base of vent	

<i>Extended list of operations</i>		
station (date/time UTC)	instruments used /samples /comments	location
13:00:04	Bottle C9 =42ROV2; T _{KIPS} =367° pH=6.75 Cl=n.d	
13:05:26	Bottle C8 =42ROV3; T _{KIPS} =367° pH=4.33 Cl=380	
13:10:34	Bottle C7 =42ROV4; T _{KIPS} =368° pH=3.8 Cl=340	
13:16:30	Bottle B6 =42ROV5; T _{KIPS} =368° pH=4.28 Cl=360	
		KIPS sampler
14:26:42	IB sample = 42ROV6	
15:22:51	Ti-major bottle D1 = 42ROV7 pH=3.36 Cl=320	
15:40:32	SMoni measurement =42ROV8; shipboard examination failed	
15:53:28	SMoni measurement =42ROV9; shipboard examination failed	
	KIPS fluids ROV11-ROV14 from top of vent	
16:13:42	No bottle filled? =42ROV10; T _{KIPS} =220°	
16:49:06	Bottle B5 =42ROV11; T _{KIPS} =?° pH=5.69 Cl=520	
16:54:41	Bottle B4 =42ROV12; T _{KIPS} =?° pH=6.76 Cl=n.d.	
17:10:01	Bottle A3 =42ROV13; T _{KIPS} =?° pH= Cl=	
17:13:56	Bottle A2 =42ROV14; T _{KIPS} =?° pH=5.95 Cl=n.d.	
17:30:59	SMoni measurement =42ROV15; shipboard examination failed	
		pillow lava at Golden Valley
18:03:41	Lava rock sample = 42ROV16	ROV at 4°48.159 S, 12°22.298 W
18:08:28 <i>leaving bottom 19:24 ROV</i>		

<i>Extended list of operations</i>		
station (date/time UTC)	instruments used /samples /comments	location
<i>on deck</i>		
17.01.08		
entire day	ROV idle. Short circuit requires shortening of cable	
ATA-43CTD 20:38:50 – 08:10:40	LADCP, 3xMAPR, TOW-YO, no bottles, (starts on 16 th , ends on 17 th)	04°48.992S,12°25.002 @ 2804 m cable out, START 04°47.784'S,12°20.190'W bei 2700 m Tiefe, END
18.01.08		
ATA-44CTD 01:01:45 – 03:09:05	LADCP, no MAPR, 16 bottles,	04°50.500'S,12°11.898'W @ 3055 m cable out
ATA-45CTD 04:22:25 – 06:23:40	LADCP, no MAPR, 18 bottles,	04°46.503'S,12°22.798'W @ 3185 m cable out
ATA-46ROV 9:25 <i>deployment</i> 11:10:15 on <i>bottom</i>	<i>Tools: SMoni, IB-sampler, 1x He tubes, 2x Titan Majors, 2 bionets</i> <i>Sites: Wideawake and Turtle Pits</i>	<i>ship at</i> 04°48,620'S, 12°22,353'W
11:33:57	Bionet sample = 46ROV1 at Wideawake	
11:38:14 to 13:20:18	Mapping Wideawake lave fields	
11:57:45	Basalt sample = 46ROV2	
		Fossil submarine lava gauge in Wideawake field
13:10:25	Basalt sample = 46ROV3	04°48.656'S, 12°22.265'W; @ 2983 m water depth
13:45:43	Slurp gun sampling of mussels; bottle 1= 46ROV4	04°48.632'S, 12°22.331'W
13:58:36	Slurp gun sampling of mussels; bottle 2= 46ROV5	

<i>Extended list of operations</i>		
station (date/time UTC)	instruments used /samples /comments	location
		First colonialization (?) of lava by mussels
	<i>Site: Two Boats</i>	
16:15:30	IB sample = 46ROV6	4°48.577S, 12°22.412 W
16:57:54	Bottle C9 =46ROV7; T _{KIPS} = 180° pH=3.47 sensor is displaced by 2 cm from nozzle	Cl=470 KIPS temp.
17:01:52	Bottle C8=46ROV8,.....T _{KIPS} = 180° pH=n/a because of sensor problem	Cl=n/a no temp.
17:58:06 <i>leaving bottom 19:15 on deck</i>		
ATA- 47CTD 20:24:00 – 22:11:23	LADCP, no MAPR, 16 bottles, 1 bottle not closed	04°51.297'S, 12°19.504'W @ 2944 m cable out
ATA- 48CTD 23:09:30 – 01:03:10	LADCP, no MAPR, 20 bottles, 1 "Schöpfer" not closed	04°52.000'S, 12°21.453'W @ 3271 m cable out
19.01.08		
ATA- 49CTD 02:04:03 – 03:53:20	LADCP, no MAPR, 16 bottles	04°53.003'S, 12°23.350'W @ 3035 m cable out
ATAROV50 09:40:42 <i>deployment 11:29:15 on bottom</i>	<i>Tools: 1x Titan Majors, 2 bionets, IB-sampler, Shovel; port drawer configured for rocks</i> <i>Site: Inside Corner High 1</i>	<i>Ship coordinates</i> 5°05.3771'S, 11°39.393'W
13:26:05	Rock sample = 50ROV1, Mn-encrusted peridotite breccia	05°05.622'S, 11°39.764'W, depth 3094m
15:24:48	Rock sample = 50ROV2, melano-gabbro	05°05.746'S, 11°40.045'W

<i>Extended list of operations</i>		
station (date/time UTC)	instruments used /samples /comments	location
		depth 2775 m
16:21:56	Rock sample = 50ROV3, small serpentinite mylonite	05°05.830'S, 11°40.170'W, depth 2696 m
16:24:21	Rock sample = 50ROV4, small piece of microgabbro or dolerite	05°05.830'S, 11°40.170'W, depth 2696 m
16:34:58	Rock sample = 50ROV5, large piece of leucogabbro with corner of felsic intrusive	05°5.815'S, 11°40.191'W, 2670m
16:55:45	Rock sample = 50ROV6, gabbro with two merging high T shear zones	05,840'S, 11°40,289'W, depth 2592 m
17:22:19	Rock sample = 50ROV7, qtz-diorite intrusive into gabbro pegmatite and regular gabbro	05°05.827'S, 11°40.311'W, depth 2555m
17:32:25 <i>leaving bottom 18:43 on deck</i>		Leaving traverse for today at 05°05.833'S, 11°40.372'W, depth 2484 m
ATA- 51CTD 23:39:28 – 08:07:40	LADCP, 3x MAPR, 3 bottles, YoYo, hit ground from 05:22:33 to 05:26:09	04°47.998'S, 12°22.353'W @ 3005 m cable out
20.01.08		
ATA- ROV52 10:00 <i>deployment: 11:43 on bottom</i>	<i>8-channel T-logger; 4 bionets, He tube</i>	04°48.102' S, 12°22.286' W, depth 2992 m
	Site Golden Valley, further planned operations were cancelled due to failure of Posidonia position system 	Amazing volcanic morphology in Golden Valley

<i>Extended list of operations</i>		
station (date/time UTC)	instruments used /samples /comments	location
		mussel cemetery in Golden Valley area
13:59:38	Bottle C9 =52ROV1; T _{KIPS} =8.9°C° pH= 7.61 Cl=n.d.	
		view of mussel field in Golden Valley area
14:04:08	Bottle C8 =52ROV2; T _{KIPS} =8.6°C° pH=7.08 Cl= n.d.	
14:09:13	Bottle C7 =52ROV3; T _{KIPS} =8.5°C° pH=6.92 Cl= n.d.	
14:13:10	Bottle B6 =52ROV4; T _{KIPS} =8.9°C° pH=6.97 Cl= n.d.	
14:20:04	Bottle B5 =52ROV5; T _{KIPS} =8.0°C° pH=6.79 Cl= n.d.	
14:24:45	Bottle B4 =52ROV6; T _{KIPS} =8.3°C° pH= 6.84 Cl= n.d.	
14:28:43	Bottle A3 =52ROV7; T _{KIPS} =7.8°C° pH= 6.88 Cl= n.d.	
14:36:52	Bottle A2 =52ROV8; T _{KIPS} =8.8°C° pH=6.96 Cl= n.d.	
14:41:51	Bottle A1 =52ROV9; T _{KIPS} =8.8°C° pH= 7.29 Cl= n.d.	
15:09:10	8-channel T-probe, = 52ROV10, T _{max} = 6°C°	
15:51:39	mussels in net B = 52ROV11	
16:12:15	collecting rock fragments with shovel = 52ROV12	
16:35:26	placing bionet as marker = 52ROV13	
17:20:08 leaving bottom		

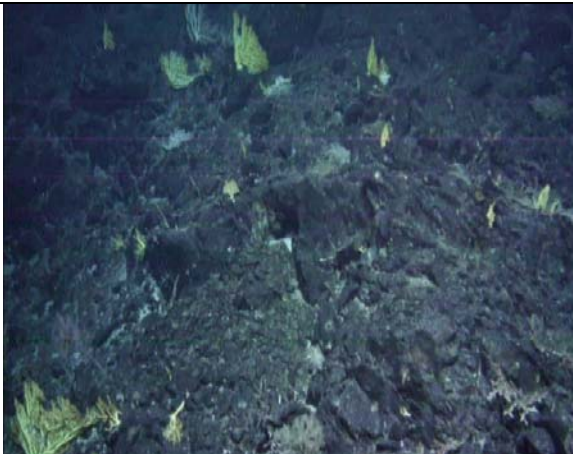

<i>Extended list of operations</i>		
station (date/time UTC)	instruments used /samples /comments	location
18:39 <i>ROV on deck</i>		
ATA53VSR c. 20:30	volcanic glass = 53VSR1	Ship at 04°46.914'S, 12°22.596', depth at contact 3139 m
21.01.08		
ATA54VSR c. 23:30	volcanic glass = 54VSR	ship at 04°46.48'S, 12°22.52'W, depth at contact 3161 m
ATA55VSR c. 03:00	volcanic glass = 55VSR	ship at 04.46.093'S, 12°23.209'W, depth at contact 3207 m
ATA56VSR c. 06:00	sediment = 56VSR	ship at 04°43.962'S, 12°24.061'W, depth at contact 3321 m
ATA- ROV57	<i>Tools: IB sampler, 2 bionets; 1x He tubes, 2x Titan Majors</i>	Ship at 4°48.558'S, 12°22.463'W; depth 2989
09:36:00 <i>deployment</i> 11:03:43 <i>on bottom</i>		
	<i>Site: Turtle Pits</i>	
13:34:09	Rock sample from chimney = ATA-57ROV-1	
15:35:56	Bottle C9 =57ROV2; T _{KIPS} = >220°C	pH=6.57 Cl=n.d.
15:39:44	Bottle C8 =57ROV3; T _{KIPS} = >220°C	pH=5.38 Cl=n.d.
15:43:06	Bottle C7 =57ROV4; T _{KIPS} = >220°C	pH= 2.85 Cl=360
15:46:46	Bottle B6 =57ROV5; T _{KIPS} = >220°C	pH=4.51 Cl=430
16:47:22	IB tube = sample 57ROV6	
18:32:11	Collecting beacon 11	
19:01:09	Collecting beacon 10	
19:09:17	Bionet with mussels = 57ROV6	
19:29:31 <i>leaving bottom</i> 20:50 <i>on deck</i>		
ATA58VSR c. 22:30	volcanic glass = sample 58VSR	<i>ship at 04°49.36'S, 12°22.53'W, depth at contact 3019 m</i>
22.01.08		

<i>Extended list of operations</i>		
station (date/time UTC)	instruments used /samples /comments	location
ATA59VSR c. 1:30	volcanic glass = sample 59VSR, bulk of sample lost before on board	<i>ship at</i> 04°50.965'S, 12°22.024'W; depth at contact 3097 m
ATA60VSR c. 4:30	volcanic glass = sample 60VSR	<i>ship at</i> 04°51.959'S, 12°21.533'W, depth at contact 3233 m
ATA61VSR c. 7:30	sediment plus bit volcanic glass = 61VSR	<i>ship at</i> 04°52.985'S, 12°21.533'W, water depth at contact 3310 m
	<i>Service on ROV, no flying today</i>	
ATA- 62CTD 09:16:59 – 03:31:55 23.01.08	LADCP, 3x MAPR, no bottles	<i>ship at</i> 04°47.394'S, 12°22.600'W @ 3086 m cable out
ATA- 63ROV	<i>Tools: 1x Titan Majors, 2 bionets, IB-sampler, Shovel, port drawer configured for rocks</i>	<i>ship at</i> 5°05.848'S, 11°40.429'W
	<i>Site: Inside Corner High 2</i>	
09:00:00 <i>deployment;</i> 10:44:04 <i>on bottom</i>		05°05.798'S, 11°40.368'W 2489m depth
11:12:57	Rock sample = 63ROV1, coarse-grained gabbro	05°05.854'S, 11°40.356'W at depth 2472m
11:29:56	Rock sample = 63ROV2, medium-grained gabbro	05°05.863'S, 11°40.369'W at depth 2430m
12:01:49	Rock sample = 63ROV3, microgabbro	05°05.919'S, 11°40.382'W at depth 2324m
12:20:56	Rock sample = 63ROV4, medium-grained gabbro	05 05.927S, 11°40.433'W at 2265m
		steeply dipping fault plane developed in a gabbro cliff
12:51:22	Rock sample = 63ROV5, medium-grained gabbro	05°05.931'S, 11°40.527'W at depth 2175m

<i>Extended list of operations</i>		
station (date/time UTC)	instruments used /samples /comments	location
13:25:59	Rock sample = 63ROV6, medium-grained gabbro	05°05.968'S, 11°40.583'W. at depth 2082m
14:01:40	Rock sample = 63ROV7, coarse-grained gabbro	05°06.022'S, 11°40.698'W at depth 1978m
14:25:11	Rock sample = 63ROV8, medium-grained gabbro	05°06.013'S, 11°40.817'W at depth 1876m
15:01:56	Rock sample = 63ROV, microgabbro	05°06.059'S, 11°40.843'W at depth 1767m
15:25:58	Rock sample = 63ROV10, perhaps basaltic with felsic magmatic veins	05°06.081' S, 12°40.949'W at depth 1673.8 m
15:40:14	Rock sample = 63ROV11, microgabbro	05°06.089'S, 11°40.982'W at depth 1636m
16:34:02	Rock sample = 63ROV12, medium-grained gabbro with net veins	05°06.104'S, 11°41.061'W at depth 1521m
16:52:28	Rock sample = 63ROV13, peridotite breccia	05°06.118'S, 11°41.102'W at depth 1491m
17:18:11	Rock sample = 63ROV14, ultramylonitic rock?	05°06.093'S, 11°41.125W at depth 1529 m
		probable ultramylonitic peridotite 50 m below edge of inside corner high plateau
17:26:25	Rock sample = 63ROV15, peridotite breccia	5°06.116'S, 11°41.101'W at depth 1492 m
		coral grown ultramafic breccia on plateau of inside corner massif

<i>Extended list of operations</i>		
station (date/time UTC)	instruments used /samples /comments	location
17:32:39 <i>leaving bottom 18:29 .on deck</i>		
ATA- 64CTD 23:50:14 – 01:38:30 24.01.08	LADCP, 1x MAPR, 20 bottles	04°48.848'S, 12°22.298'W @ 2983 m cable out
ATA- 65CTD 02:32:12 – 04:22:40	LADCP, 1x MAPR, 20 bottles	04°22.40'S, 12°22.395'W @ 2992 m cable out
ATA- 66CTD 05:07:45 – 07:06:00	LADCP, 1x MAPR, 20 bottles	04°47.902'S, 12°22.492'W @ 3023 m cable out
ATA- 67ROV	<i>Tools:</i> IB-sampler, 1x He tubes, 2x Titan Majors, 2 bionets, rock-bio box	<i>Ship at</i> 4°48.661S, 12°22.60'W, depth 2995 m
	<i>Site:</i> Red Lion	
09:20:00 <i>in water</i>	Fly one mile to correct location	
11:42:31 on bottom		04°47.821'S, 12°22.641'W at depth of 3048 m
13:15:27	Slurp gun collects shrimps = 67ROV1	
13:21:28	Slurp gun collects shrimps = 67ROV2	
14:29:54	Ti-major bottle D2 = 67ROV3	pH=3.51 Cl=490
14:48:17	Bottle C9 =67ROV4 T _{KIPS} = 350°C	pH=4.01 Cl=530
14:51:51	Bottle C8 =67ROV5 T _{KIPS} = 363°C	pH=2.85 Cl=540
14:54:39	Bottle C7 =67ROV6 T _{KIPS} = no T°C	pH=3.62 Cl=560
14:58:58	Bottle B6 =67ROV7 T _{KIPS} = no T°C	pH=5.06 Cl=540
15:05:43	Bottle B5 =67ROV8 T _{KIPS} = no T°C	pH=3.22 Cl=560
15:17:12	He-sample = 67ROV9	
15:19:35 <i>leaving bottom 16:26 on deck</i>	Leaving ground early because of oil leak from slurp gun	
ATA-		<i>Ship at</i> 4°48.152'S,

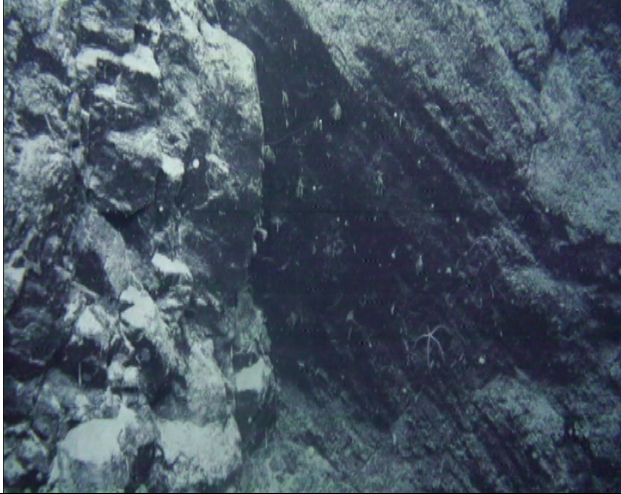
<i>Extended list of operations</i>		
station (date/time UTC)	instruments used /samples /comments	location
ROV68		12°22.381'W, depth 2995 m
17:17:15 <i>in water</i> 18:33:16 <i>on bottom</i>	<i>Site: Comfortless Cove area</i>	4°48.090'S, 12°22.384'W, depth 3002 m
	Searching in a 120 x 120 m square for oceanographic tool (mooring) suspected in this area, but no success	
21:36:55 leaving bottom 22:45..on deck		
ATA- ROV69	Mooring loaded with MMP,700m length	
23:10 deployment 02.55 <i>released</i>		04°48.197'S,12°22.510'W, depth 3004 m
25.01.08		
ATA- ROV70	<i>Tools: 1x Titan Majors, 1 bionet, IB-sampler, Shovel, port drawer configured for rocks</i>	<i>Ship at 4°56.420'S, 11°37.044'W, depth 4765m</i>
	<i>Site: North wall of transform, 5°S at nodal basin</i>	
10:45:00 <i>in water,</i> 13:04:39 <i>at bottom</i>		11°36.987W, 04°56.473'S depth 4864 m
	Testing ROV functions at large depths	
16:53:37	Subvolcanic basalt = 70ROV-1	04°56.336'S, 11°37.057'W 4753 m
17:53:56	Microgabbro to diabase = 70ROV-2	04°56.258'S, 11°37.055'W depth 4654 m
18:11:10	Solidified foraminiferous ooze = 70ROV-3	04°56.231'S, 11°37.073'W depth 4617 m
18:15:26	Doleritic basalt = 70ROV-4	04°56.231'S, 11°37.073'W depth 4617 m
18:42:12	Microgabbro to diabase = 70ROV-5	04°56.145'S, 11° 37.088'W depth 4515 m
18:58:35	Doleritic basalt = 70ROV-6	04°56.124'S, 11°37.111'W depth 4468 m

<i>Extended list of operations</i>		
station (date/time UTC)	instruments used /samples /comments	location
19:44:17	Basaltic with flow texture = 70ROV-7	04 56.046'S, 11°37.131 depth 4343 m
		striations related to movement on a steep fault. They appear to truncate a sheeted dyke complex visible in foreground
20:12:40	Diabase = 70ROV-8	04 56.028'S, 11°37.114 depth 4252 m
		well developed sheeted dykes in cliff face of the transform wall
20:38:45	Diabase = 70ROV-9	04° 55.990'S, 11°37.124'W, depth 4175m
21:13:58	Diabase = 70ROV-10	04°55.983'S, 11°37.113'W, depth 4063m
21:37:21	Basaltic breccia = 70ROV-11	04°55.895'S, 11°37.148'W, depth 3996m
22:00:15	Diabase = 70ROV-12	04°55.816'S, 11°37.166'W, depth 3897m,
22:17:13	Diabase = 70ROV-13	04° 55,765'S, 11°37.201'W, depth 3825m

<i>Extended list of operations</i>		
station (date/time UTC)	instruments used /samples /comments	location
22:29:45	Diabase = 70ROV-14	04°55.757'S, 11°37.212' W, depth 3815m
22:32:08 <i>leaving bottom 00:06. on deck</i>		

Table A2: Results from on-board chemical analyses and measured data

Location	Station Nr.	Sample ID	Bottle	Sample Type	Date	T (C)	pH	Eh	H2S (µM)	H2S (µM)	Fe (II) mg/l	Fe (II) µM	Fe (tot) (mg/l)	Fe (tot) (µM)	Fe (tot) (mM)	Cl (mM)	O2 (µM)	
Two Boats, top	35 ROV	7	D1	hot fluid	14.01.2008		6.44	5	n.d.		8.53	152.3	9.74	221	173.9	550		
	35 ROV	8	D2	hot fluid	14.01.2008	429-451*	2.92	-245		3323	216	3657	9.74	221	3946	310		
Wideawake 1	37 ROV	1	C9	diffuse fluid	15.01.2008	7-11	7.5	-50		1.16	0.1	1.8	0.85	0.85	15.2	560	226	
	37 ROV	2	C8	diffuse fluid		4-11	7.05	-206		47.24	0.45	8.0	0.85	0.85	8.9	550		
	37 ROV	3	C7	diffuse fluid		8-11	7.29	-180		14.65	0.78	13.9	1.23	1.23	22.0	560		
	37 ROV	4	B6	diffuse fluid		n.a.	7.03	-217		76.16	0.38	6.8	0.41	0.41	7.3	560		
	37 ROV	5	B5	diffuse fluid		12-16				27.96	0.45	8.0	0.74	0.74	13.2	560		
	37 ROV	10	B4	diffuse fluid		8-9	7.5	-213.6		39.1	0.13	2.3	0.19	0.19	3.4	550		
	37 ROV	11	A3	diffuse fluid		5-7	7.42	-212.7		33.12	0.17	3.0	0.24	0.24	4.3	560	270	
	37 ROV	12	A2	diffuse fluid		6	7.39	-217.9		48.59	0.13	2.3	0.13	0.13	2.3	550		
	37 ROV	13	A1	diffuse fluid		9	7.5	-176.3		12.23	0.44	7.9	1.39	1.39	24.8	555		
		42 ROV	2	C9	hot fluid	16.01.2008	367	6.75			100	4.42	79.0	4.36	4.36	77.9		
Sisters Peak, bottom	42 ROV	3	C8	hot fluid		367	4.33		6650	6038	115.03	2054.1	119.26	2129.7	370			
	42 ROV	4	C7	hot fluid		367	3.8		9960	8494	174.06	3108	176	176	3141	330		
	42 ROV	5	B6	hot fluid		367	4.28		4300	3960	122.48	2187.2	111.35	1988.4	370			
	42 ROV	6	gas	hot fluid		367												
	42 ROV	7	D1	hot fluid		n.d.**	3.36		7800	9296	184.18	3289	205	205	3667	310		
	42 ROV	11	B5	hot fluid		n.d.**	5.69		530	2219	24.30	433.9	26.57	474.5	520			
Sisters Peak, top (1)	42 ROV	12	B4	hot fluid		n.d.**	6.76		<30	38	4.19	74.9	3.92	69.9				
	42 ROV	14	A1	hot fluid		n.d.**	5.95		110	251	20.78	371.0	23.08	412.1				
Two Boats, bottom	46 ROV	7	C9	hot fluid	18.01.2008	max: 412	3.47	-222.7		1466	74.46	1330	83.67	83.67	1494	470		
	52 ROV	1	C9	diffuse fluid	20.01.2008	8.9	7.61	2.6			1	0	0.0	0.08	1.4		450	
Golden Valley	52 ROV	2	C8	diffuse fluid		8.6	7.08	-136		21	0.11	2.0	0.18	3.2				
	52 ROV	3	C7	diffuse fluid		8.5	6.92	-170		43	0.2	3.6	0.23	4.1				
	52 ROV	4	B6	diffuse fluid		8.9	6.97	-128		20	0.55	9.8	1.25	22.3				
	52 ROV	5	B5	diffuse fluid		8	6.79	-196		56			0	0				
	52 ROV	6	B4	diffuse fluid		8.3	6.84	-186		40			0.02	0.4			244	
	52 ROV	7	A3	diffuse fluid		7.8	6.88	-195		22	0	0.0	0	0			290	
	52 ROV	8	A2	diffuse fluid		8.9	6.96	-26.3		7	1.04	18.6	2.39	42.7				
	52 ROV	9	A1	diffuse fluid		8.8	7.29	68.4		1	0.79	14.1	1.65	29.5				
		57 ROV	2	C9	hot fluid	21.01.2008	max: 371	6.57	10		4	7.58	135.4	10.03	179.1			
Two Boats, bottom	57 ROV	3	C8	hot fluid		5.38	5.88	-290		925	27.01	482.3	30.54	545.4				
	57 ROV	4	C7	hot fluid		2.85	-189		4782	167.5	2991	216	216	3657	360			
	57 ROV	5	B6	hot fluid		4.51	-274		2561	63.28	1130.0	73.22	1307.5	430				
Mephisto	67 ROV	3	D2	hot fluid	24.01.2008		3.51	-224.4		3865	15.88	280.0	21.54	384.6	490			
	67 ROV	4	C9	hot fluid		363	4.01	-207.4		3990	33.94	606.1	33.61	600.2	530	0		
	67 ROV	5	C8	hot fluid		363	2.85	-180.2		7465	40.8	729	44.3	791	540			
	67 ROV	6	C7	hot fluid		363	3.62	-215.2		6336	37.39	667.7	46.74	834.6	560			
	67 ROV	7	B6	hot fluid		363	5.06	-241.2		2203	15.34	273.9	13.74	245.4	540			
	67 ROV	8	B5	hot fluid		363	3.22	-190.8		7593	47.88	855	52.19	932	560			

* max: T range measured in the same orifice

** T sensor failed

Table A2: Results from on-board chemical analyses and measured data (cont.)

Location	Station Nr.	Sample ID	Bottle	Sample Type	Date	T (C)	pH	Eh	H2S (µM)	H2S (µM)	Fe (l) mg/l	Fe (l) µM	Fe (tot) (mg/l)	Fe (tot) (mM)	Cl (mM)	O2 (µM)
Two Boats, top	35 ROV	7	D1	hot fluid	14.01.2008		6.44	5	n.d.	1.57	8.53	152.3	9.74	173.9		550
	35 ROV	8	D2	hot fluid	14.01.2008	429-451*	2.92	-245	3370	3323	216	3857	221	3946		310
Wideawake 1	37 ROV	1	C9	diffuse fluid	15.01.2008	7-11	7.5	-50		1.16	0.1	1.8	0.85	15.2		560
	37 ROV	2	C8	diffuse fluid		4-11	7.05	-206		47.24	0.45	8.0	0.5	8.9		550
	37 ROV	3	C7	diffuse fluid		8-11	7.29	-180		14.65	0.78	13.9	1.23	22.0		560
	37 ROV	4	B6	diffuse fluid		n.a.	7.03	-217		76.16	0.38	6.8	0.41	7.3		560
	37 ROV	5	B5	diffuse fluid		12-16				27.96	0.45	8.0	0.74	13.2		560
	37 ROV	10	B4	diffuse fluid		8-9	7.5	-213.6		39.1	0.13	2.3	0.19	3.4		550
	37 ROV	11	A3	diffuse fluid		5-7	7.42	-212.7		33.12	0.17	3.0	0.24	4.3		560
Wideawake 2	37 ROV	12	A2	diffuse fluid		6	7.39	-217.9		48.59	0.13	2.3	0.13	2.3		550
	37 ROV	13	A1	diffuse fluid		9	7.5	-176.3		12.23	0.44	7.9	1.39	24.8		555
	42 ROV	2	C9	hot fluid	16.01.2008	367	6.75		390	100	4.42	79.0	4.36	77.9		
Sisters Peak, bottom	42 ROV	3	C8	hot fluid		367	4.33		6650	6038	115.03	2054.1	119.26	2129.7		370
	42 ROV	4	C7	hot fluid		367	3.8		9960	8494	174.06	3108	176	3141		330
	42 ROV	5	B6	hot fluid		367	4.28		4300	3960	122.48	2187.2	111.35	1988.4		370
	42 ROV	6	gas	hot fluid												
	42 ROV	7	D1	hot fluid		n.d.**	3.36		7800	9296	184.18	3289	205	3667		310
	42 ROV	11	B5	hot fluid		n.d.**	5.69		530	2219	24.30	433.9	26.57	474.5		520
Sisters Peak, top (1)	42 ROV	12	B4	hot fluid		n.d.**	6.76		<30	38	4.19	74.9	3.92	69.9		
	42 ROV	14	A1	hot fluid		n.d.**	5.95		110	251	20.78	371.0	23.08	412.1		
Two Boats, bottom	46 ROV	7	C9	hot fluid	18.01.2008	max: 412	3.47	-222.7		1486	74.46	1330	83.67	1494		470
	52 ROV	1	C9	diffuse fluid	20.01.2008	8.9	7.61	2.6		1	0	0.0	0.08	1.4		450
Golden Valley	52 ROV	2	C8	diffuse fluid		8.6	7.08	-136		21	0.11	2.0	0.18	3.2		
	52 ROV	3	C7	diffuse fluid		8.5	6.92	-170		43	0.2	3.6	0.23	4.1		
	52 ROV	4	B6	diffuse fluid		8.9	6.97	-128		20	0.55	9.8	1.25	22.3		
	52 ROV	5	B5	diffuse fluid		8	6.79	-196		56			0			
	52 ROV	6	B4	diffuse fluid		8.3	6.84	-186		40			0.02	0.4		244
	52 ROV	7	A3	diffuse fluid		7.8	6.88	-195		22	0	0.0	0			290
	52 ROV	8	A2	diffuse fluid		8.9	6.96	-26.3		7	1.04	18.6	2.39	42.7		
	52 ROV	9	A1	diffuse fluid		8.8	7.29	68.4		1	0.79	14.1	1.65	29.5		
	57 ROV	2	C9	hot fluid	21.01.2008	max: 371	6.57	10		4	7.58	135.4	10.03	179.1		
Two Boats, bottom	57 ROV	3	C8	hot fluid		5.38	-290		925	27.01	482.3	30.54	545.4			
	57 ROV	4	C7	hot fluid		2.85	-189		4782	167.5	2991	216	3857		360	
	57 ROV	5	B6	hot fluid			4.51	-274		2561	63.28	1130.0	73.22	1307.5		430
	57 ROV	3	D2	hot fluid			3.51	-224.4		3885	15.68	280.0	21.54	384.6		450
	67 ROV	4	C9	hot fluid	24.01.2008		4.01	-207.4		3990	33.94	606.1	33.61	600.2		530
Mephisto	67 ROV	5	C8	hot fluid		363	2.85	-180.2		7465	40.8	729	44.3	791		540
	67 ROV	6	C7	hot fluid		363	3.62	-215.2		6336	37.39	667.7	46.74	834.6		560
	67 ROV	7	B6	hot fluid		363	5.06	-241.2		363	15.34	273.9	13.74	245.4		540
	67 ROV	8	B5	hot fluid		363	3.22	-190.8		7593	47.88	855	52.19	932		560

* max. T range measured in the same orifices

** T sensor failed

Appendix 3

ROV dive protocols

ArcGIS Mapping with numbers below:

- 1 - pelagic sediment (totally covering seafloor)
- 2 - rocks (outcropping or blocks)
- 3 - hydrothermal sediment
- 4 - hydrothermal crust
- 5 - active sulfide chimney
- 6 - inactive sulfide chimney
- 7 - diffuse venting
- 8 - bacterial mat
- 9 - mussle field
- 10 - single mussels
- 11 - scarp
- 12 - fluid sampling
- 13 - mussle sampling
- 14 - geophysical instrument
- 15 - T logger
- 16 - T mooring

Cruise Number Atalante Leg 2
Station Number 35ROV
Dive Number #13
Location Turtle Pits
Coordinates 4°48.566'S 12° 22.4497'W
Water Depth 2988m
Vessel Atalante

Metadata **Observation**
 Timecode allowed
 default

Actions
 allowed

9:00:00 Begin Station
 9:39:00 ROV in Water
 10:18:51 Stop at 1013m, pressure drop in Compensator Node 1

 10:19:36 Time check - this computer is 6 seconds behind UTC
 11:11:35 Bottom sighting
 11:13:11 9 m off bottom, not much to see
 11:15:01 Directly in front of us is Pinnocchio apparently, not visible in science lounge
 11:15:55 Sheet flow, flat topped, striated surface
 11:17:08 Mussels on top of flow, not sure if living or dead
 11:18:08 Mussel beds in Turtle Pits
 11:21:12 Ship 4 48.5696S 12 22.4497, ROV 4 48.562 12 22.415
 11:23:38 Still adjusting winch
 11:24:31 Slowly drifting northward, away from pits
 11:26:46 White balance check on cameras
 11:27:11 Marker 3 in front of us.
 11:27:42 HD an, go south (young man)
 11:30:03 HDTV shows no mussels but white mats
 11:30:27 Shimmering water with hydroth. Deposits
 11:31:18 Marker 2, at foot of Two Boats, net fish
 11:31:41 Marker partially buried in sulphide talus.
 11:36:02 Flying around smoker looking for a good point to sample
 11:37:36 Strange root-like structure at base of smoker, isolated shrimps swimming around
 11:40:28 Still filming HDTV, Southern tower visible in distance.
 11:41:05 Preparing to deploy beacon
 11:41:18 HDtV off
 11:47:18 Looking for a place to putr beacon
 11:50:59 On bottom, placing beacon
 11:51:10 HDTV On Seafloor near beacon
 11:52:07 HDTV Off
 12:09:08 Trying to place beacon
 12:13:22 Beacon placed at 12 22.418W 4 48.579S fix from Poseidonia now



HDTV ATA-35ROV_1

HDTV ATA-35ROV_2

12:14:11 HDTV On, fly round of Homer beacon
 12:15:15 HDTV Off
 12:17:50 Moving back to Two Boats to take temperature and samples
 12:19:16 Chimney at Two Boats is 6 m high.
 12:24:51 Looking for a sampling position
 12:26:27 Nupsie ab!
 12:26:51 Another try
 12:28:50 Sampling of chimney material not easy, very friable
 12:33:33 carb in sight
 12:33:50 preparing for T measurement => KIPS deployment
 12:35:30 HDTV On Foot of Two Boats smoker (not too exciting, some shrimp)
 12:36:10 KIPS handle in ORION
 12:36:28 HDTV Off
 12:38:08 nozzle placed in smoking exit of chimney.
 12:39:57 trying to find a suitable site
 12:44:04 180°C measured max T
 12:44:28 227°C measured max T
 12:45:47 exit widened with nozzle
 12:48:02 nozzle deep in exit 410 Tmax measured
 12:49:25 starting to fill KIPS bottle C9
 12:50:30 HD camera on, KIPS nozzle in Two Boats smoker
 12:51:24 T constant at 407 - 408°C
 12:52:42 HD camera off
 12:53:12 pump shifted off

HDTV ATA-35ROV_3

HDTV ATA-35ROV_4

ATA-35ROV1

HDTV ATA-35ROV_5

12:53:51 pumps on bottle C8
 12:54:24 T max measured is 417°C
 12:58:18 pumps off
 12:58:46 T constant at 407 - 408°C
 12:58:59 pumps on bottle C7
 13:03:11 pumps off
 13:03:53 measured T: 400 to 410° currently 412°C
 13:04:20 pumps on bottle B6
 13:07:43 pumps off
 13:09:12 pumps on bottle B5
 13:10:19 ROV: 4 48.578S 12 22.412W
 13:13:32 pumps off
 13:14:14 pumps on bottle B4
 13:18:53 420°C measured max
 13:19:14 pumps off, KIPS finished, change to Ti-Majors
 13:21:20 HDTV On Two Boats smoker again
 13:21:49 KIPS back in garage; perfect drive
 13:22:09 HDTV Off
 13:23:23 handling Ti-Majors, positioning bottle D1
 13:23:30 HDTV On Preparing Ti-Majors deployment in Two Boats
 14.01.2008 13:24 HDTV Off
 13:28:12 positioning Ti-Majors nozzle in the same hole as before
 13:30:51 waiting for "clear" water at the fitting of the nozzle tube
 first try to close the valve of D1; probably problems with closing the valve ; probalby fluid was already
 13:36:16 sampled;current attempt interrupted, new try
 13:38:03 fine adjustment of nozzle
 13:43:11 still positioning the nozzle
 13:47:54 Filling of bottle D1 is finished; not clear whether bottle worked properly
 13:56:23 positioning Ti-Majors bottle D2
 13:58:23 positioning the nozzle auf bottle D2 in the hole
 14:01:28 waiting for "clear" water at the fitting of the nozzle tube; new try

ATA-35ROV2

ATA-35ROV3

ATA-35-ROV4

ATA-35ROV5

ATA-35ROV6

HDTV ATA-35ROV_6

HDTV ATA-35ROV_7

ATA-35ROV7



14:06:32 still positioning the nozzle
 14:07:40 HDTV On Ti-Majors D2 in Two Boats chimney
 14:08:23 HDTV Off
 14:09:04 waiting for clear water at the fitting of the nozzle tube
 14:11:20 drop off of bottle D2 from ORION
 14:13:01 successful fishing of the bottle D2
 14:15:02 ORION positions bottle D2
 14:18:12 next try
 14:20:37 looking for locations in the chimney; breaking away some parts of the chimney
 14:26:09 positioning the nozzle auf bottle D2 in the hole
 14:29:37 next try in the same hole
 14:31:23 waiting for clear water at the fitting of the nozzle tube
 14:31:30 HDTV On Ti-Majors in Two Boats again
 14:32:51 not clear whether bubbles inside the fluid or not
 14:33:36 ready to fire: closing of valve D2
 14:34:39 sussessful closing of valve of D2

HDTV ATA-35ROV_8

14.01.2008 14:35 HD off
 14:40:25 positioning of bottle D2 in box
 taking up of S-Moni: attempt to measure temperature in the same hole where Ti-Majors bottle D2 was
 14:41:15 filled
 14:43:32 starting of T measurement with S-Moni in the same hole
 14:50:30 finishing of T measurement with S-Moni
 14:53:15 KIPS sampling st the same point; bottle A3
 14:57:42 seems that bubbles are present inside the fluid
 15:00:31 positionig of the KIPS nozzle, breaking some parts away
 15:00:52 HDTV On, 2nd KIPS sampling at Two Boats, Rimicaris sitting in black smoke
 15:01:11 Kipps-Temperatures: 370, 410, 420, 452 °C; 452°C stable
 15:02:16 pumps on
 15:03:16 measured T: 451°C
 15:06:35 pumps off
 15:06:40 HDTV Off
 15:07:18 KIPS bottle A2, pump on
 15:07:38 HD was running a while, now off
 15:12:13 pump off
 15:12:48 KIPS bottle A1, pump on
 15:14:41 Temperature decreases, now 427°C
 15:17:03 KIPS pump off, Temp nozzle stays inside for checking temperature evolution
 15:19:58 427-428 °C measured; further positioning for reproducing initial high Temperature (450°C)
 15:20:55 measured 438°C
 15:22:36 476°C
 15:23:05 506°C max T measured!!
 15:24:29 another S-Moni deployment in order to confirm these extemely high T

HDTV ATA-35ROV_9
 ATA-35ROV8

ATA-35ROV9

HDTV ATA-35ROV_10

ATA-35ROV10

ATA-35ROV11

ATA-35ROV12

15:31:26 S-Moni nozzle deeply inserted into the smoking exit of the chimney
15:31:40 HDTV On Smoni zoomed in at Two Boats
15:32:40 HD has been on for a while
14.01.2008 15:34 HD off
15:36:26 End of S-Moni deployment after 5 minutes
15:43:01 Deployment of Cu-tube for He-sampling (AA label)
15:44:40 HDTV On, He sampling handling
15:50:08 Cu-tube successfully placed in rigmaster
14.01.2008 15:50 HD off
15:53:01 funnel of Cu-tube being placed on top of exiting black smoke,
15:54:02 unexpected chimney collapse
15:55:53 looking for suitable place to locate the funnel
15:58:51 HD camera on, He sampling
15:59:25 black smoke exiting from Cu-tube
16:00:14 closing Cu tube: top closed
16:01:17 bottom valve closed
14.01.2008 16:01 HD off
16:04:24 deployment of second Cu-tube (Label BB)
14.01.2008 16:05 HD on, Smoke at Two Boats (uninteresting)
14.01.2008 16:07 HD off
16:09:02 Cu-tube in Rigmaster
16:10:45 smoke exiting Cu-tube
16:12:34 upper valve closed
16:14:12 lower valve closed
16:24:58 placement of both Cu-tubes into sample box
16:26:56 next target: taking sulfide rock sample
16:39:41 some fragments of a sample put into the white plastic box (no sample #)
16:43:09 attempt to use the net for sulfide sampling
16:46:27 fishing of very fragile samples with the net
16:47:53 attempt to use the slurp gun for fishing shrimps
16:54:00 HDTV On Slurp gunning shrimps
16:54:37 taking up slurp gun with ORION
16:56:03 positioning the slurp gun for shrimp fishing
16:59:31 slurp on: rock particles and shrimps visible flushing into the bottle 1
17:05:03 Another try to catch a big shrimp
17:07:28 Changing to bottle 2, slurp gun on
17:10:46 visible in bottle2: fragments of rocks, dust, shrimps
14.01.2008 17:11 HD off
17:14:50 still slurping; seems not very efficient to catch shrimps
17:17:18 at least one shrimp visible, swimming in the tube above bottle 2
17:28:21 slurping rock fragments and shrimps, visible in the tube above bottle 2
17:33:51 loss of slurp gun from ORION
17:34:00 finishing of slurp gun fishing for bottle 2
17:35:21 fishing of the "Schlauchschelle" and dropping into the container box
17:39:19 Southern Tower in sight
17:40:09 Leaving the bootom

ATA-35ROV13

HDTV ATA-35ROV_11

ATA-35-ROV14

HDTV ATA-35ROV_12

HDTV ATA-335ROV_13

ATA-35ROV15

HDTV ATA-35ROV_14

ATA-35ROV16

ATA-35ROV17

HDTV ATA-35ROV_15

ATA-35ROV18

Cruise Number Atalante Leg 2
Station Number 37ROV
Dive Number #14
Location Wideawake
Coordinates 4°48.549'S 12° 22.5051'W
Water Depth 2992m
Vessel Atalante

Metadata **Observation**
 Timecode allowed
 default

Actions
 allowed

9:30:00 Begin Station
 9:39:00 ROV in Water
 11:12:23 Bottom sighting, unsedimented lava, not fresh flow. 12°22,339W 4° 48,618'S.
 11:14:00 HDTV On, Flight over Wideawake field, camera too high and Die Fast in picture
 11:14:54 Going S, mussel beds
 11:16:23 Mussel bed,
 11:17:24 Taking close-ups of mussel beds, looking for clams
 11:17:12 HDTV Off
 11:18:03 12 22,338W 4 48,624S ROV Position
 15.01.2008 11:19 HDTV On, mussel bed
 11:21:41 Polyps
 11:26:09 Swimming worms in front of porch
 Fish and mussels
 11:26:21 HDTV Off
 11:29:33 Preparing to place beacon
 11:31:00 Beacon at 12 22,342W 4 48,626S
 11:33:25 Looking at mussels to see if alive or dead
 11:37:26 decide to check around for larger mussel field
 15.01.2008 11:39 HDTV On, mussel bed
 11:43:32 ROV set down, looking for sampling position
 15.01.2008 11:44 HDTV Off
 11:49:11 die-fast machine removed from ROV and employed on seafloor
 11:53:00 HDTV On, KIPS sampling of mussel bed
 11:53:22 KIPS measurement 14 degree W 12 22.339 S 04 48. 618 to S 04 48.622
 11:54:29 HDTV Off

HDTV ATA-ROV37_1

HDTV ATA-ROV37_2

HDTV ATA-ROV37_3

HDTV ATA-ROV37_4



11:54:47 pump is on
 11:57:18 KIPS zwischen 7 und 11 Grad
 11:58:57 pump off
 11:59:21 KIPS pump on, T varies between 4 and 7 degrees
 12:03:19 pump off
 12:04:44 KIPS pump on
 12:05:57 T zwischen 8 und 11 Grad
 12:07:13 for one minute T between 4 and 6 degrees
 12:07:17 pump off
 12:10:45 KIPS pump on, 9 degrees
 12:12:00 HDTV On, KIPS in mussel bed again
 12:13:00 HDTV Off
 12:14:15 pump off
 12:14:53 KIPS pump on
 12:16:17 T = 12 to 16 degrees
 12:18:54 pump off
 12:20:00 HDTV On, Close-up of mussels
 12:20:30 HDTV Off
 12:23:12 try release 8-channel T lance
 12:29:14 still finding best place to measure with 8 channel lance
 12:31:05 T in channel ranges from 16.7 to 4.4
 12:32:00 HDTV On, 8-channel T lance in mussel bed
 12:32:43 HDTV Off
 12:34:05 lance buried in mussel field for about 1/3, rest is out of water
 12:34:10 announce that measurement will take up to 20 mins
 12:50:53 taking lance from bottom; stop of T measurement, B9 35 min, T max 15°C, at the bottom tip
 12:52:56 next attempt: mussel fishing, use slurp gun
 12:53:37 lance back in garage
 12:56:25 first mussel gripped with ORION
 13:11:44 plan: taking mussels with net, the fishing shrimp for placing into die-fast
 13:13:01 taking of net #3
 13:16:02 trying to fish mussels in net#3
 13:29:31 still trying to fish mussels
 13:40:26 still trying to fish mussels

ATA 37ROV-1, Flasche C-9

ATA 37ROV-2, Flasche C-8

ATA 37ROV-3, Flasche C-7

ATA 37ROV-4, Flasche B-6

HDTV ATA-ROV37_5

ATA 37ROV-5, Flasche B-5

HDTV ATA-37ROV_6

ATA 37ROV-6

HDTV ATA-37ROV_7

13:44:02 successful fishing of a bunch of mussels
 13:46:15 successful fishing of another bunch of mussels into the same net
 13:49:46 drop of net#3 filled with mussels into box
 13:51:49 new positioning of die-fast
 15.01.2008 13:52 HD on, for taking movies of the diffuse fluid field
 15.01.2008 13:53 HD off
 13:54:57 taking the slurp gun
 13:57:26 attempt to slurp shrimps where the diffuse fluid comes out
 14:00:12 first shrimp visible in the tube above the bottle....and finally escaped
 14:01:18 slurping more shrimps
 14:03:12 a slurped mussle is stucked in the slurp nozzle
 14:08:03 attempt to use the slurp gun for picking mussels bunches
 14:11:07 finishing of first shrimp sampling into bottle 1; eventually one shrimp inside
 14:13:58 new positioning of die-fast on the mussle field with shimmering water
 15.01.2008 14:17 HD on, for taking movies of the die-fast in the mussle bed
 15.01.2008 14:18 HD off
 15.01.2008 14:20 HD on
 14:21:20 Opening of die-fast
 15.01.2008 14:21 HD off
 new positioning of die-fast on the mussle field with shimmering water, since it was located at that
 14:24:49 plache where the former mussle sampling with net was performed
 14:28:40 starting to take mussels for die-fast
 14:33:09 try to use the slurp gun for carrying mussels into the die-fast
 14:40:26 finishing of use of slurp gun for mussle fishing
 notice: all the time gaz bubble visible in the camera observing slurp gun tube
 14:41:57 using ORION for taking bunches mussels
 14:42:54 dropping of first mussels from the same field of before into die-fast
 14:44:43 continuing of dropping mussels into die-fast
 14:48:00 "the pot is full"; closing the lid
 14:51:30 new positioning of die-fast
 15.01.2008 14:53 HDTV on MUSSELS IN DIE FAST
 15.01.2008 14:53 HD off
 14:56:35 check if lid of the chamber is closed properly

ATA 37ROV-7

HDTV ATA-ROV37_8

ATA 37ROV-8

HDTV ATA-ROV37_9

HDTV ATA-37ROV_10

ATA 37ROV-9

HDTV ATA37ROV_11

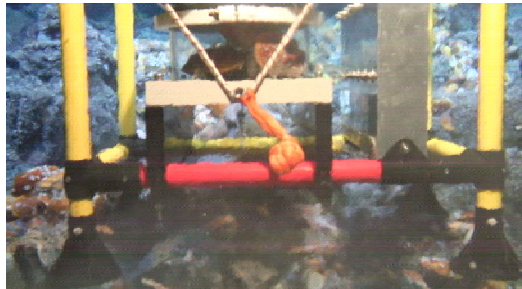

15:03:20 DIE-FAST initiated: mussels executed!
 15:25:24 leave this point heading for another mussel field
 15:26:00 HDTV on, flight across Wideawake
 15:30:33 heading: 249°, dense thicket of polyps
 15:32:18 sedimented lava flow, likely north of Wideawake
 15:32:30 HDTV Off
 15:34:00 HDTV On, flight back to Wideawake and landing on mussel bed
 15:34:25 heading 140°, search for the mussel bed
 15:38:50 large area covered densely with mussels, 4°48,639 S; 12°22,356 W
 15:47:01 new reading: 4°48,639 S; 12°22,343 W
 15:52:05 7,5°C temperature in mussel bed
 15:55:50 HDTV Off
 15:57:00 HDTV On, KIPS in 2nd mussel field
 15:58:16 8-9°C temperature in mussel bed, pump on, filling bottle B4
 16:00:04 HDTV Off
 16:01:02 HD camera off
 16:02:21 pump off
 16:05:02 pump on, 5-7°C, filling bottle A3
 16:08:19 pump off
 16:08:57 pump on, 6°C, filling bottle A2
 16:12:46 pump off
 16:14:33 pump on, 9°C, filling bottle A1
 16:19:26 pump off
 16:25:00 HDTV On, just a mussel bed
 16:25:11 HDTV Off
 16:29:00 HDTV On 8-channel T sensor in 2nd mussel field
 16:29:50 measuring with 8-channel T lance, 18° at the tip of lance (C1)
 16:34:01 hdtv 6ff
 16:39:49 end of T lance measurement. T max was 22°C
 16:49:45 lance back in holder
 16:50:10 leaving ground due to low oil pressure
 16:53:07 end of dive

HDTV ATA-ROV37-12

HDTV ATA-ROV37_13

ATA 37ROV-10
 HDTV ATA-ROV37_14

ATA 37ROV-11

ATA 37ROV-12

ATA 37ROV-13

HDTV ATA-ROV37_15

ATA 37ROV-14
 HDTV ATA-ROV37_16

Cruise Number Atalante Leg 2
Station Number 42ROV
Dive Number #15
Location Comfortless Cove
Coordinates 4°48,188' S 12°22,301' W
Water Depth 2996m
Vessel Atalante

Metadata
 Timecode
 default

Observation
 allowed

Actions
 allowed

8:00:00 Begin Station
 8:20:00 ROV in Water
 10:48:04 Bottom sighting
 10:51:31 Sheet flow
 10:52:09 Pillows with sediment in gaps
 10:53:08 Lobate flows, flattened pillows
 10:57:25 Hydrothermal deposits
 10:58:00 HDTV On, flight to sister's peak
 10:58:30 Collapse structures in lava flow, white hydroth. Deposits (mats?)
 11:01:07 Turning to find smoker
 11:02:45 Lots of old smoker rubble, no active black smoke to see
 11:03:37 HDTV Off
 11:03:53 Oops, there it is
 11:04:43 Sister's Peak 4°48,222'S 12°22,270'W
 11:09:39 2nd inactive peak visible
 11:12:32 Waiting for computer reboot
 11:15:03 Still sorting computer out, 16m above ground.
 11:17:00 HDTV On, Sister's peak approach and lower third, wobbly
 11:18:44 Going to make a vertical profile of the smoker, computer problems sorted out apparently
 11:21:23 Hydrothermal rubble
 11:22:14 4 48, 227 S 12 22,272W
 11:22:52 Mussels visible in HDTV and shrimp
 11:24:18 Some shimmering water seen on flanks of structure
 11:25:11 HDTV close-up of shrimps and shimmering water
 11:25:57 HDTV Off
 11:26:39 Adjusting white balance of cameras
 11:31:55 HDTV on, top of Sister's Peak
 11:33:09 White colour not shrimps, looking with HDTV
 11:34:01 White colour not filamentous, looks like precipitates
 11:43:31 Top of smoker, fantastic view
 11:45:03 Sonar computer crashed again
 11:45:56 Chimney 10,3m high
 11:46:56 HDTV off
 11:53:27 HDTV on, top of Sister's Peak again then descent
 11:55:09 Going to try T measurement at top of active smoker
 12:01:08 Going down and around the chimney
 12:03:00 cloud of shrimps chased from chimney
 12:05:06 about 7m high, patches of dense shrimps
 12:06:26 HDTV off

HDTV ATA-42ROV_1

HDTV ATA-42ROV_2

HDTV ATA-42ROV_3

HDTV ATA-42ROV_4

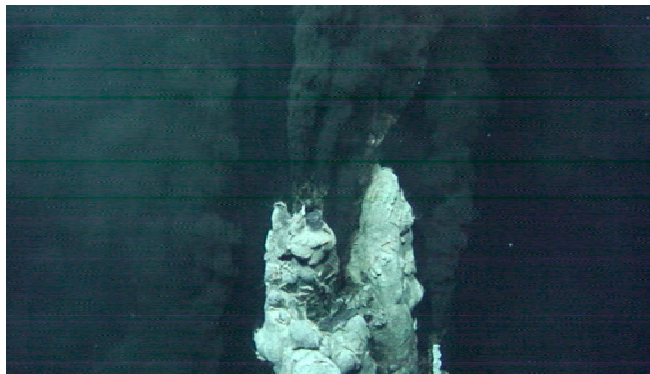

12:07:27 shimmering water, 7m
 12:07:55 HDTV on, slow pan of Sister's peak summit
 12:10:18 Chimney is from the south side 16m 50cm high
 12:12:57 Looking at dead spire
 12:14:58 Marker 5 looking 345°
 12:19:02 looking 227°, in front of small chimney releasing black smoke
 12:20:05 diffuse outflows and dense shrimps, Bathymodiolus
 12:22:05 HDTV off
 12:43:26 opening at the top of little knob, two chimney pieces on porch
 12:45:13 computer crashed again
 12:48:15 HDTV on, KIPS foot Sister's Peak

HDTV ATA-42ROV_5

42 ROV-1

HDTV ATA-42ROV_6

12:49:19 HDTV off
 12:53:07 220°C, KIPS T Sensor close to orifice
 12:53:50 360°C
 12:57:58 stable 367°C, short-term 370°C
 12:58:31 start to sample with KIPS, water depth is 2996,1 m, ROV parking on talus
 13:00:04 pump on, bottle C9, T stable at 367°C 42 ROV-2
 13:04:54 pump off
 13:05:26 pump on, bottle C8, T stable at 367°C 42 ROV-3
 13:08:54 pump off
 13:10:34 pump on, bottle C7, T stable at 368°C 42 ROV-4
 13:14:52 pump off
 13:16:30 pump on, bottle B6, T stable at 368°C 42 ROV-5
 13:20:45 pump off
 parking the KIPS took longer than anticipated
 13:42:25 HDTV on, parking KIPS
 13:43:24 HDTV off

HDTV ATA-42ROV_7

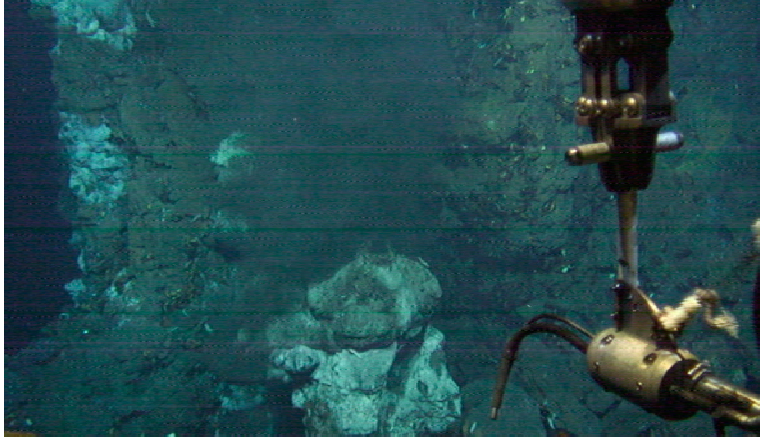

13:49:24 KIPS handle on porch, cannot move to park position anymore
 14:15:23 prepare to utilize the isobaric sampler
 14:24:49 start taking a sample with the isobaric sampler by opening the valve a full turn
 14:26:42 sample taken 42 ROV-6
 14:27:12 closing valve again
 14:55:56 taking Ti-Majors D1 from the box
 15:02:18 trying to position D1 nozzle; bad conditions for viewing due to heavy smoke
 15:09:17 positioning of D1 nozzle into exit
 15:11:06 new try
 15:15:51 positioning of D1 nozzle in exit
 15:17:55 new try
 15:19:07 positioning of D1 nozzle in exit
 trying to close the valve of D1; problems with closing the valve; sample was taken, but eventually
 15:22:51 only filled partly 42 ROV-7
 15:25:32 stop with the attempt of sampling with Ti-majors; next step: S-Moni measurement
 15:31:43 dropping of Ti-Majors D1 bottle into the box
 15:32:43 Taking S-Moni from the box
 15:40:32 starting measuring with S-Moni 42 ROV-8
 15:46:33 stop T measurement
 15:47:11 looking for another position for S-Moni
 15:53:28 starting measuring with S-Moni at another location as before 42 ROV-9
 15:54:40 stop T measurement
 15:56:27 attempt to measure Temp in the same exit with KIPS
 16:06:58 positioning of KIPS in the same exit where second S-Moni measuring was performed
 16:13:42 measured T: max 220°C 42 ROV-10
 16:14:44 measured T: max 365°C
 16:16:33 HD on; moving to the top of Sister's Peak
 16:22:58 HD off
 16:30:46 HD on, smoke!
 16:31:26 HD off
 16:32:20 HD on, smoker fingers at top SP
 16:33:03 HD off
 16.01.2008 16:34 HD on, smoke
 16:34:50 HDTV Off
 16:40:22 Deployment of KIPS: nozzle apparently inserted in fluid exit but low T reading ("Badewanne")
 16:45:03 still trying to locate position for Sampling hot fluids
 T sensor of KIPS is faulty: constant reading of 27°C even in background water: plan sample fluids by
 16:47:38 KIPS
 16:49:06 pumps on filling bottle B5 42 ROV-11
 Plan: fill KIPS, fill one Ti-major then proceed towards Golden Valley in order to obtain a basalt
 16:51:26 sample. Expected time of leaving ground: 17:00
 16:53:50 pump is off
 16:54:41 pumps on filling bottle B4 42 ROV-12
 16:58:18 pump off; KIPS sampling finished.
 17:10:01 pumps on filling bottle A3 42 ROV-13

HDTV ATA-42ROV_8

HDTV ATA-42ROV_9

HDTV ATA-42ROV_10

HDTV ATA-42ROV_11

17:13:47 pumps off
17:13:56 pumps on filling bottle A2
17:17:35 pumps off, end of KIPS sampling
17:30:59 S-Moni deployment in order to obtain Temperature
17:33:20 S-Moni measurement finished
17:42:56 move 20 m North
17:46:50 HDTV on, pillow hill N of SP
17:47:38 pillow flow, looking for sampling site
17:51:22 HDTV off

42 ROV-14

42 ROV-15

HDTV ATA-42ROV_12



17:58:25 start sampling a piece of lave crust from pillow; 4°48,159 S, 12°22,298 W
17:59:15 HDTV on, sampling pillow
18:02:38 HDTV off
18:03:41 small piece of lava collected and placed into sampling drawer at front
18:08:24 collecting a second piece, placed in box 3
18:08:28 ROV off bottom

HDTV ATA-42ROV_13

42 ROV-16

Cruise Number Atalante Leg 2
Station Number 46ROV
Dive Number #16
Location Wideawake & Bturtle Pits
Coordinates 4°48.610'S/12°22.342'W
Water Depth 2987m
Vessel Atalante

Metadata	Observation	Actions
Timecode	allowed	allowed
default		

8:15:00 Begin Station
 8:25:00 ROV in Water
 9:43:47 533m
 10:06:05 1300m
 10:27:57 1600m
 10:44:53 2160m
 11:04:28 2800m
 11:08:51 seafloor in sight; ROV 2958m 22 m over ground, some high structure visible
 11:10:15 4°48,620'S 12°22,353'W
 11:11:34 Target find homer beacon, sonar on
 11:12:23 jumbled flow some mussle patches
 11:15:35 homer beacon found
 11:16:50 next action: take mussle sample from this site
 11:18:55 suitable site for mussle sampling located
 11:19:49 HDTV On, mussel patch in Wideawake
 11:20:48 HD off
 11:21:16 HDTV On, snails in mussel patch at Wideawake
 11:21:22 sonar off
 11:22:06 HD off
 11:24:51 Orion takes bio net (no lable) in claw
 11:25:54 HD on, unsuccessful mussel sampling at Wideawake
 11:29:27 Need to change bionet position in claw
 11:29:49 HD off
 11:31:08 orion manoever successful
 11:31:01 HDTV on, SUCCESSFUL MUSSEL sampling
 11:33:42 HDTV off
 11:33:57 bionet sampling completed
 11:37:52 shimmering water and mussle beds
 11:38:14 heading 110, search for lava flow front to the east
 11:38:58 jumbled flow
 11:39:50 reached flow front of 2002? Flow, lobate
 11:40:09 HD on, flying east 110 heading over fresh flow
 11:43:04 HD off
 11:43:19 4°48,612'S 12°22,316'W, lobate flow
 11:44:47 HD on, flying over contact and then into old sedimented flow
 11:45:50 strong sediment cover here, older flow
 11:46:42 turn heading to 270 to investigate contact
 11:47:47 HD off
 11:47:34 collapse structure

 11:48:19 HD on of contact young flow to older flow looking south; older flow east and young flow to the west.
 11:49:56 HD off
 11:50:23 4°48,612S 12°22.295W location of contact and sampling
 11:50:50 HDTV On, young flow to sampling of old flow
 11:51:29 HD on without thrusters
 11:51:52 ROV being pulled to the back, thrusters on

 found nice spot to take basalt sample. Overhang of older lava flow. The younger flow is located in the
 11:53:19 collapse structure of the older flow. Apparently utilizing the pre-existing lava tube drainage system.
 11:53:30 HDTV Off
 11:54:25 HD on, sampling old flow with Rigmaster
 11:57:45 sample in Rigmaster claw, 4°48,612S 12°22.295'W, 2985m
 11:58:04 HD off
 11:59:39 working with orion in order to place sample into sample box
 12:09:07 relocating for restarting mapping procedures
 12:19:08 proceeding towards south
 12:20:16 back in fresh glassy lobate flow
 12:20:40 HDTV On, flight over new flow
 12:20:44 crossing from older to younger flow
 12:21:05 just passed across the mapped (ABE) island of older lava
 12:21:59 flying over fresh lobate 2002 flow
 12:23:29 contact to lightly sedimented lava flow 4°48.660 12°22.293'W
 12:24:47 back in fresh glassy lobate flow
 12:25:52 very nice fresh luster on young lobate flow
 12:28:30 ROV flying to the south for a while. Ship needs to follow up.
 12:29:44 moved 140m south from sample 46ROV-2. Depth: 2984m
 12:30:38 still flying over fresh lobate lava flow
 12:32:46 Continue flying to the south. Still young lava flow.
 12:33:12 HD off
 12:34:13 HDTV On, southern boundary of flow with skylights in old flow
 12:34:18 Contact 183 m from last sampling, turning W to check surrounding
 12:35:47 the older sheet flow is highly sedimented, collapse structure in sight
 12:36:46 sonar off
 12:37:21 checking out collapse structure, very nice pillar 4°48,717'S 12°22.290'W

HDTV ATA-46ROV_1

HDTV ATA-46ROV_2

HDTV ATA-46ROV_3

HDTV ATA-46ROV_4

ATA-46ROV-1

HDTV ATA-46ROV_5

HDTV ATA-46ROV_6

HDTV ATA-46ROV_7

HDTV ATA-46ROV_8

ATA-46ROV-2

HDTV ATA-46ROV_9

HDTV ATA46ROV_10

12:39:05 great view of pillar structures! Text book example!
 12:40:22 Is the tube flow filled with rubble or younger jumbeld flow? Difficult to make out.



HDTV ATA-46ROV_11

12:41:15 Flying to the east heading 90
 12:41:57 HD still on
 12:42:18 Flying quickly to the east (0.4 kn)
 12:43:17 back into older sedimented lava flow at 64 m distance from the collapse structure examined
 12:43:54 HD off
 12:47:53 moving north now, heading 10
 12:49:10 back in fresh glassy lobate flow
 12:49:53 flying across contact, young lobate lava flow overlying older, more sedimented jumbled flow
 12:50:51 Flow front apparently shifting eastwards. New heading 10 to 20
 12:51:57 small embayment of older lava flow ("Wideawake flow")
 12:52:20 HD on, old flow
 12:53:06 fresh young lobate lava flow with glassy luster
 12:53:31 nice plastic deformation texture
 crossing from older to younger flow; localized embayment. This serrated nature of the contact
 12:54:25 indicates that we are really close at the eastern flow margin
 12:54:49 HD off
 Another contact; superbly exposed! Older flow is jumbled with pronounced hummocky structure.
 12:56:10 Younger flow is flowing around this structure. Displace niceropy, fioded flow top structure, locally.
 12:57:03 HDTV On, young flow and eastern contact to Wideawake flow
 12:59:40 Returning to contact location in a wider turn to the south
 13:01:30 HDTV Off
 back at superb contact site, trying to obtain a sample of the older jumbled flow. It may well be the wideawake flow (ie., the stuff the mussels are growing on). However, this is may as well be an independent flow.
 13:04:20
 13:06:44 4°48,656'S 12°22,265'W; 2983 m
 13:08:35 sampling operations started with Orion
 13:10:25 Basalt piece placed in Box 1 of sample sledge. Older jumbled flow sampled
 13:11:40 Heading north, measuring distance from this sampling site
 13:13:07 back in fresh glassy lobate flow
 13:13:28 very nice flow top structures
 13:13:44 Another contact: local embayment of old jumbled flow.
 13:14:35 back in fresh glassy lobate flow
 13:15:49 Another contact, local embayment of older jumbled flow.
 13:16:12 back in fresh glassy lobate flow
 13:16:24 lobes on flow top are aligned in N-S direction.
 13:19:18 Impressive lava tube structures. 83 m from last sampling site. 4°48.606'S 12°22.275'W
 13:20:18 Heading N on to of the older sheet flow, heavy sediment covering, local collapse structures.
 13:21:16 Aiming for Turtle Pits beacon.
 13:27:13 contact fresh lava

HDTV ATA-46ROV_12

HDTV ATA-46ROV_13

ATA-46ROV-3

18.01.2008 13:28 HD on, west over new flow until a diffuse field found east of Wideawake boundary (i.e. on young flow)
 13:32:54 HDTV Off
 cluster of young mussels at the top of fresh lavas, at S4 48.632S W12 22.331; dusty water, not
 13:33:09 shimmering
 13:37:07 aim to investigate mussel cluster; looking for small species
 13:39:27 attempt to use slurp gun for small mussels
 13:43:44 taking slurp gun
 18.01.2008 13:45 HD on, slurping larger mussels
 13:45:43 starting to slurp small mussels into bottle 1
 13:50:34 slurp gun back to garage
 13:50:42 HDTV Off
 13:51:45 attempt to look in detail for the mussel field nearby
 18.01.2008 13:51 HD on, zoom in on small mussel site
 13:56:06 attempt to zoom in with HD to check whether the whitish structures visible are really mussels
 13:57:28 taking slurp gun
 13:58:36 Slurping young, small mussels into bottle 2

HDTV ATA-46ROV_14

ATA-46ROV-4
 HDTV ATA-46ROV_15

HDTV ATA-46ROV_16
 ATA-46ROV-5



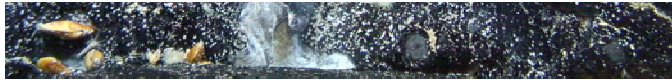

14:04:03 HDTV Off
dropping of slurped mussels into front slit near IB sampler of the box; same smple# as a above.
14:05:58 INCLUDES basalt glass chips (some appear to have also dropped into box 1)
14:08:06 finishing slurp gun sampling; aim to fly to Turtle pits
14:10:48 next step: finding Wideawake beacon
14:16:06 attempt to get posidonia data failed
14:17:10 got signal from beacon
14:19:18 got signal from Turtle Pits beacon: 180m away, heading 305
14:23:08 Posidonia is running again
14:25:53 fresh young lobate flow above older lava ; 4° 48.606S 12° 22.369W
14:26:42 heavy sediment cover
14:27:12 jumbled flow
14:27:33 minor sediment cover
14:28:30 old smoker in sight
14:30:18 Turtle pits beacon in sight
14:35:05 Southern Tower? in sight
14:37:36 Two boats in sight
14:47:01 moving ship
14:57:40 attempt to find smoker
14:59:22 smoker in sight, two boats?
15:01:11 marker in sight;
15:11:02 waiting for the final ship position
15:16:11 still waiting for the ship
15:17:00 finding marker 2, the position where fluid samples from first day were taken
15:23:02 found lot to park ROV, 4°48.577S and 12°22.412 W
15:28:07 artificial hole of T measurement from first day still smoking away
15:32:53 preparing to release the tube = IB sampler
15:42:04 problems to release the tube
15:46:47 handing over the tube to the rig master
little chimney has grown already on the new outlet, broken off to place the tube, will attempt to pick
15:54:33 up later
15:56:48 tube apparently place properly
16:01:32 after new grip on tube with rig master, tube now placed onto vent
16:07:46 problems to open valve, also funnel no more over vent.
16:13:00 HDTV On IB-Sampler
16:13:24 HDTV Off
16:13:28 tube turned so that opening the valve will be easier
18.01.2008 16:14 HD on, IB sampler at Two Boats
16:15:30 opening valve! Of IB samples.
18.01.2008 16:15 HD off
16:16:30 closing valve
16:20:00 rigmaster has released the IB sampler
16:25:45 placing IB sampler into drawer
16:27:53 KIPS fever measurement is being prepared
16:33:19 KIPS is out of garage
16:33:20 HDTV On, KIPS at Two Boats
16:34:00 HDTV Off
16:36:52 T = 412°C
16:37:12 T = 370°C
16:41:18 T = 380°C
16:48:55 announcement that T-sensor of nozzle ripped off
16:51:19 KIPS inlet and T nozzle have been twisted during search for hot fluid exit
16:57:54 Filling bottle C9, 180°C measured but sensor about 2 cm displaced from nozzle
17:00:45 pumps off
17:01:52 pumps on, bottle C8
17:04:32 stopped filling of bottle C8. Not enough fluid discharging from KIPS exhaust.
17:06:11 interruption of KIPS sampling, potentially nozzle is blocked
17:14:16 nothing much happening
17:17:41 leaving current sampling site
17:19:20 HDTV On, black smoke, nothing else
17:19:40 looking at top of two boats smoker
17:20:11 >HDTV Off
17:22:03 or is it southern tower?
17:24:25 looking for a suitable orifice
17:26:16 KIPS deployment
17:32:09 looking for a suitable orifice
17:36:39 T measurement by KIPS sensor at intensely discharging orifice. Abandoned.
18.01.2008 17:39 HD on, bent KIPS
18.01.2008 17:40 HD off
17:47:59 reapproaching orifice, T measurement?
17:51:58 KIPS away from orifices
17:52:18 new attempt
KIPS T sensor in orifice (max T measured is 300°C... But this is not the discharge T, T sensor not
17:55:20 properly inserted in orifice).
17:58:06 end of dive. Leaving bottom.

HDTV ATA-46ROV_17

ATA-46ROV-6
HDTV ATA-46ROV_18

HDTV ATA-46ROV_19

ATA-46ROV-7

ATA-46ROV-8

HDTV ATA-46ROV_20

HDTV ATA-46ROV_21

NOTE ADDED chimney fragment from Southern Tower in the back of ROV - sample number assigned after dive

ATA-46ROV-9

Cruise Number Atalante Leg 2
Station Number 50ROV
Dive Number #17
Location Inside Corner High #1
Coordinates 5°05,3771'S 11° 39,393'W
Water Depth 3403m
Vessel Atalante

Metadata	Observation	Actions
Timecode default	allowed	allowed

9:30:00 Begin Station
 9:40:42 ROV in Water
 11:08:16 2700 m
 11:25:53 20m above bottom 5°05.451 S; 11°39.300 W
 11:29:15 bottom sight
 11:30:49 heavily sedimented
 11:32:56 start traverse with heading 252°
 11:40:00 HDTV on, prawn on sedimented seafloor
 11:41:08 HDTV off
 11:42:00 HDTV On, strange slug
 11:47:47 HDTV Off
 11:47:35 HDTV on, 5°05.522S; 11°39.428W, still only sediment
 11:53:24 HDTV off
 11:59:07 sonar shows solid structures in the distance
 11:59:25 large boulders, ? Talus; 5°05.524S; 11°39.468W, near WP 1, 3390 m
 12:04:48 trying to get a better picture of the rocks, also waiting for the ship
 12:06:45 waiting for ship
 12:15:28 continue traverse with direction 252°, sedimented area
 12:17:52 more boulders, 5°05.545S; 11°39.508W, 3356 m
 12:18:54 slope steepens now
 12:21:19 reaching foot of the slope at 3320m, start measuring the distance
 12:23:59 3300m water depth
 12:25:06 more large blocks and plenty of sediment
 12:28:46 large boulders
 12:31:40 more blocks, 3230m depth, 5°05.620S; 11°39.624W
 12:38:29 Large boulder, 3207 depth
 12:41:45 sediment
 12:42:03 boulder, looking for suitable spot in order to take a rock sample
 12:42:46 steep hill side, highly sedimented some blocks sticking out of the ground
 12:48:24 suitable rock in sight. 5°05.610'S 11°39,658'W, 3143m
 12:52:36 sompling of this particular fragment abandoned
 12:53:50 proceeding towards 270
 12:55:21 new sampling target localized
 12:57:40 proceeding a little further to the west
 12:59:05 more large blocks and plenty of sediment
 13:02:14 shift change of ROV pilots
 13:07:29 more large blocks and plenty of sediment
 13:08:16 3110m 5°5,618S 11°39.753W
 19.01.2008 13:10 HD on, boulders in sediemtn
 19.01.2008 13:11 HD off
 13:12:24 sampling initiated
 13:19:06 sampling abandoned
 13:19:45 continue heading 270. bolders and sediment.
 13:22:59 another go at sampling
 19.01.2008 13:24 HD on, sampling
 13:25:32 HD off
 Sampling was successful! Sample: looks like breccia with thick layer of solidified foram ooze.
 13:26:05 5°05.622S 11°39.764'W. 3094m
 13:29:58 proceeding to the W. Still large boulders and sediment.
 13:34:10 more large blocks and plenty of sediment
 13:35:56 sediment
 13:36:03 blocks
 13:36:22 big blocks
 13:37:05 steep rocky cliff, in-situ rocks?
 19.01.2008 13:38 HD on, flight over boulder field
 13:38:41 terrace full of sediment
 13:39:09 5°05.647'S 11°39.831W 3013M
 19.01.2008 13:39 HD off

HDTV ATA-50ROV_3

HDTV ATA-50ROV_5

This video is not present

HDTV ATA-50ROV_7

HDTV ATA-50ROV_8

ATA-50ROV-1

HDTV ATA-50ROV_9

13:40:23 proceeding towards 242, boulders and sediment.
13:41:09 sediment
13:41:43 3000 m, sediment
13:41:58 sediment and boulders
13:44:31 sediment and boulders. Heading 246, try to find another sample
13:48:07 sediment and boulders. 2960m
13:52:12 try to take sample
19.01.2008 13:57 Hd on, sampling attempt
19.01.2008 13:58 HD off
14:01:40 sampling abandoned
14:01:53 still slope with abundant blocks and sediment
14:06:52 HD on, capture a panoramic view of the slope
14:07:52 HD off
14:30:44 2875m depth
14:36:35 trying to collect a sample
14:44:00 sediment and boulders
14:49:40 still trying to sample. 2842m.
14:50:34 sampling abandoned
14:52:51 sediment and boulders
19.01.2008 14:53 HD on, boulders on slope
19.01.2008 14:54 HD off
15:01:36 trying to take sample
15:02:17 2810 m 5°05.728'S 11°40.016'W
15:07:15 sampling abandoned
15:08:26 very steep slope, big blocks
15:09:51 investigating blocks
15:11:05 proceeding heading 272
15:11:41 sediment on slope
15:11:53 heading 290
15:13:45 5°05.746'S 11°40.045'S 2775 m, ROCK FACE striking N-S
investigating outcrop: black rock with 10s of cm wide vein running parallel (NO. The white stuff
is sediment.) and vertically across the outcrop
15:14:44 is sediment.) and vertically across the outcrop
15:13:30 HDTV On, big rock face and then nothing
19.01.2008 15:16 HD has been on; now switched off
15:16:53 wall is not really high, flying over
15:17:05 HDTV on, massive rocks
15:17:31 trying to grab a particular sample (knobby clast on a cliff poarch) with the rigmaster!
15:24:48 sampling SUCCESSFUL. Round knobby sample placed on poarch. Size ca. Rigmaster claw.
15:27:58 HD is on and has been on for a while
15:30:23 moving up the flank of the cliff, starting at 2783.6 m
15:30:57 passed fantastic deed sea corals (hydrozoan) living at the cliff edge
15:31:39 2768.8m Still moving up.
15:32:00 2767.5m Total of 16 m for the cliff.
15:33:17 Reached peak of a MEGA-BLOCK. Hence sample take was not in-situ.
15:34:13 Flying around cliff peak.
15:35:39 Examining cliff surface: striation are recognizable. HD still on.
15:37:00 Moving closer.
15:38:14 Rock type: Gabbro
19.01.2008 15:38 HD off
15:38:54 Examination finished. Progressing dive.
15:39:40 Cliff top colonized by Hydrozoan
15:40:32 Flying across sedimented cliff surface
15:44:33 very steep slope, heavily sedimented, abundant ripple
15:45:29 Sedimented terrace, 2772m
15:45:56 Still heading towards the west. 251
15:48:07 waiting for ship
15:49:39 Moving to the west, 250, sediment and boulders
15:54:33 sediment and boulders
15:55:47 Large boulder (size range: several m to 10s of meters) field, massive blocks, clast-supported.
15:56:59 5°5.796'S 11°40.140'W; 2730m
15:59:03 still large boulder field
16:02:35 trying to take sample
16:10:00 Huge slabby blocks, interlocking
16:11:32 Steep cliff face of large block
16:12:27 reached sedimented top of cliff
Observation: In the lower portion of the dive investigated earlier the blocks were rounded
(reminiscent of "Wollsack Verwitterung"). In contrast, in this area up here the blocks are slabby
16:13:02 with sharp angular outlines.
16:16:06 2700m
19.01.2008 16:17 HD on, landing in sedimented talus
16:17:35 Preparing for taking a sample from a local scree slope
19.01.2008 16:17 HD off

HDTV ATA-50ROV_10

HDTV ATA-50ROV_11
(Timemarks wrong on video?)

HDTV ATA-50ROV_12

HDTV ATA-50ROV_13

ATA-50ROV-2

HDTV ATA-50ROV_14

HDTV ATA-50ROV_16

sample placed in box 1 (smaller than sample ATA-ROV-1) This sample is black an shiny and may be a glassy blast crust or a Mn-crust	ATA-50ROV-3
16:23:28 5°05.830'S 11°40.170'W 2696 m. About 100m away from WP2	
16:24:21 Second sample from this location placed in box 2.	ATA-50ROV-4
16:28:29 sediment and boulders. Proceeding to W 268	
16:29:54 giant scree field.	
16:30:05 HD on.	No film
16:31:54 HD off	
16:32:39 Preparing for taking a sample from a local scree slope	
16:32:56 Rigmaster	
16:33:59 sample in rigmaster!	
16:34:58 sample with white crust, angular clast, lying on Orion side of poarch	ATA-50ROV-5
16:35:53 5°5.815'S 11°40.191'W 2670m	
16:36:48 Progressing to the west. Heading 256	
16:37:55 sediment and boulders	
16:39:32 traveling up the slope	
16:41:03 Blocks have grey surfaces, some banding perhaps visible.	
19.01.2008 16:41 HD On, boulder	
16:43:11 Was that banding or sediment? Not sure.	HDTV ATA-50ROV_17
16:43:18 HDTV Off	
16:45:00 Lots of boulders which are flat, angular. Dickbankig is the expression	
16:47:34 Still large, flat blocks,	
16:48:53 These boulders are loose - can see collision marks between them	
19.01.2008 16:51 HD On, looking for sampling site, small talus	
16:52:40 Attempting sampling	HDTV ATA-50ROV_19
19.01.2008 16:53 HD Off	
Got sample, black surface top and bottom, brown fracture surface on side, placed in rear big compartment 5°S05,824 ??? Depth??	ATA-50ROV-6
17:01:16 11 39,525 5 06,510??? Posidonia problem??	
17:02:26 5 05,840 11 40,289 is perhaps good fix	
17:05:43 Boulder field	
All joint surfaces look to dip OUT of teh slope - i.e. Towards the east, perhaps also slightly to the S	
17:06:03 S	
17:07:35 Blocks becoming more plate-like	
17:08:47 Looking at a place which looks like slickensides	
19.01.2008 17:09 HD on, big gabbro boulder	
17:10:31 Günter is sure it is slickensides	HDTV ATA-50ROV_20
17:10:53 HD Off	
17:16:00 HD Off already	
17:18:16 Facing block, steady. Going to sample	
17:22:19 Getting a sample. 5 05.827S 11 40.311W 2555m	ATA-50ROV-7
19.01.2008 17:28 HD On, in situ gabbro wall	
17:29:08 Wall strikes 340°	
17:30:10 Looking to find strike and dip of structures	HDTV ATA-50ROV-21
19.01.2008 17:31 HD Off	
17:32:25 5 05.833S 11° 40,372 2484m end of dive, coming up	
during coming up: the last wall shows a height of ~ 150 m, monitored by sonar; strike: 330°	

Cruise Number Atalante Leg 2
Station Number 52ROV
Dive Number #18
Location Golden Valley & Red Lion
Coordinates 4° 48.102'S 12° 22.286'W
Water Depth 2992m
Vessel Atalante

Metadata	Observation	Actions
Timecode default	allowed	allowed

9:00:00 Begin Station
 10:00:00 ROV in Water, problem with Posidonia signal in van, changing cables out whilst diving to 1000m
 11:27:20 2473m
 New plan for the dive: Locate golden valley without Posidonia positioning signal. Return ROV on deck immediately after sampling in order to fix this problem on deck.
 11:35:28
 11:38:14 2820m
 11:42:34 seafloor in bottom sonar
 11:43:58 seafloor in view: 2990 m
 11:44:28 sedimented sheet flow with intense laminar striations
 11:45:10 search for Sisters peak chimney structure using the sonar
 11:45:55 great view of sedimented sheet flow plain
 11:47:23 turning vehicle at 60 degrees intervals in order to locate smoker in the sonar
 11:52:30 positioning ROV several m above the ground in order to pick up Sisters peak in the sonar
 sonar shows structure that may represent Sisters Peak in the SW. Hence Golden Valley should be towards the north. Plan: Dive to the north
 11:59:57
 12:02:26 returning to seafloor
 12:03:01 round circular patches and larger domains filled with sediment on top of sheet flow
 12:04:08 turning vehicle around: Large sheet flow plain
 12:04:36 HDTV On, fight over pillows
 12:04:37 moving northwards
 12:04:56 hummocky structures
 12:05:27 contact of sheet flow to overlying pillow flow.
 12:05:55 climbing up pillow flow front
 20.01.2008 12:06 HD off
 12:07:58 very nice pillow flow morphologies, minor sediment in interstices
 20.01.2008 12:08 HD on, volcanic flight and first mussel patches
 12:10:33 mussels! Dead ones...
 12:11:37 trying to follow the "mussle gradient"
 12:12:02 living mussels and shimmering water!
 12:12:53 HD Off
 12:14:10 still trying to locate the valley. Low mussle density
 12:15:01 there is the fracture/valley!
 12:15:17 HDTV, flying south in volcanic fissure
 HD on flying southwardthis is the fissure of a major lava flow eruption, passing site of sheet flow emissions
 12:15:53
 12:18:02 great volcanic morphology



12:18:52 multiple sheetflow tops and lava tube structures
 12:20:07 HD still on, "Grand canyon-like" views
 12:24:56 some dead mussle on fissure floor
 12:25:26 HD Off
 12:26:05 plenty of crabs! Sitting on pillows
 HD on, lots of mussel patches in valley, most look dead, shimmering water everywhere (looks like activity is waning, far rewer mussels living now than shells lying around.
 20.01.2008 12:26
 12:27:32 abundant polyps around the mussle beds. Very similar situation to Wideawake.
 12:29:05 abundant dead mussels
 12:29:52 following large patches of dead mussels
 12:30:29 abundant dead mussels
 12:31:24 shimmering water around. BUT no live mussels near shimmering water. Too hot?

HDTV ATA-52ROV_1

HDTV ATA-52ROV_2

HDTV ATA-52ROV_3



- still abundant mussels. This is no longer a valley structure. Difficult for orientation. Following towards the south.
- 12:32:06 abundant dead mussels
 - 12:33:54 abundant shimmering water emitting from interstices of lava lobes.
 - 12:34:18 We crossed the southern margin of the pillow flow. Jumbles lavaflow morphologies are abundant. ROV touched the ground=> lava sample of sheet flow sitting on poarch.
 - 12:35:03 Abundant hot water emitting from the seafloor. Becoming more intense: Foggy. However, no macrofauna.
 - 12:35:41 Sheet flow top, lightly sedimented.
 - 12:36:37 NO more shimmering water. Some (minor) dead mussels.
 - 12:38:01 Bach in more active region progressing towards the east. Fissure reappears.
 - 12:38:43 Again abundant dead mussle patches and shimmering water.
 - 12:39:39
 - 20.01.2008 12:40 HD off
 - 12:40:29 Lifting ROV up into the water column in order to locate Sisters Peak using the sonar.
 - 12:50:03 returning to seafloor
 - 12:50:23 Landed on abundant mussle beds alive and dead mussels + shimmering water
 - 12:51:13 abundant living mussels!
 - 12:51:56 passing over steep cliff
 - 12:53:01 floor of fissure colonized by some mussels
 - 13:00:12 pilot change, biologists resign to idea to sample whatever they get because orientation remains difficult without Possidonia
 - 13:08:31 plan to take Ti-majors once find fluid vent
 - 20.01.2008 13:17 HD on, mussel patch
 - 20.01.2008 13:20 HD off
 - 20.01.2008 13:21 HD on, more mussels
 - 13:24:29 HD off
 - 20.01.2008 13:29 HD on, polyp close up
 - 20.01.2008 13:30 HD off
 - 20.01.2008 13:30 HD on, shrimp feeding
 - 13:31:05 HD off
 - diffuse fluid vent over entire area, trie to measure now T at margin of the mussel field with 8 channel lance, but difficult to find proper landing place
 - 13:32:53 searching for a proper sampling spot according to KIPS temperature readings. Current readings are in the 2-5 degree C range
 - 13:48:27 T 3-3.5°C and one time 5°
 - 13:55:06 T = 6.9°C!
 - 13:56:40 T = 8.6°C
 - 13:57:26 KIPS pump on, bottle C9, T = 8.9°C
 - 14:00:01 HDTV On, view over mussel field whilst sampling
 - 14:00:23 HDTV Off

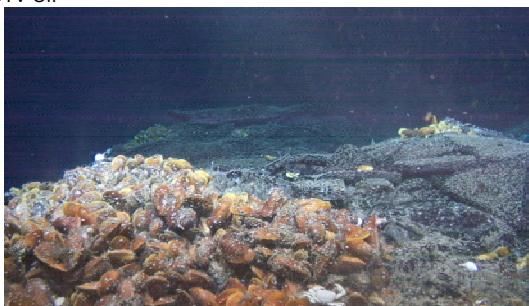

- 14:03:35 pump off
- 14:04:08 KIPS pump on, bottle C8, T = 8.6°C
- 14:08:40 pump off
- 14:09:13 KIPS pump on, bottle C7, T = 8.5°C
- 14:12:38 pump off
- 14:13:10 KIPS pump on, bottle B6, T = 8.9°C
- 14:15:45 HDTV On, view over mussel field whilst sampling
- 14:17:27 pump off
- 20.01.2008 14:17 HD off
- 14:20:04 KIPS pump on, bottle B5, T = 8.0°C
- 14:24:07 pump off
- 14:24:45 KIPS pump on, bottle B4, T = 8.3°C
- 14:28:02 pump off
- 14:28:43 KIPS pump on, bottle A3, T = 7.8°C
- 14:33:28 pump off, T = 8.0°C

HDTV ATA-52ROV_4

HDTV ATA-52ROV_5

HDTV ATA-52ROV_6

HDTV ATA-52ROV_7

HDTV ATA-52ROV_8

52 ROV-1

HDTV ATA-52ROV_9

52 ROV-2

52 ROV-3

52 ROV-4

HDTV ATA-52ROV_10

52 ROV-5

52 ROV-6

52 ROV-7

14:34:42	remove nozzle from site and return it again for a second set of fluid samples	
14:36:52	KIPS pump on, bottle A2, T = 8.8°C	52 ROV-8
14:41:08	pump off	
	Site is called "Clueless Site"	
14:41:51	KIPS pump on, bottle A1, T = 8.8°C	52 ROV-9
14:46:27	pump off, T remained constant between 8.5 and 8.8°C	
14:47:09	next task will be the 20 minute 8-Channel temperature measurement	
14:55:07	start deployment of the 8-Channel T-Logger	
15:09:10	8-Channel T-logger in position, start measuring for 20 minutes, T-max 6°C	52 ROV-10
15:35:48	stop of T-measurement	
15:36:32	next step: fishing mussels for Nicole	
15:37:50	8-Channel T-logger back in garage	
15:42:41	taking net # B	
15:51:39	fishing mussels into net # B	52 ROV-11
15:53:22	drop of of net # B into box 1	
15:55:25	opening of of lid from plastic box	
	taking rock sample covered with bio; sample broke; only small fragments placed into plastic box with	
15:58:54	lid; no sample number	
15:58:58	taking another rock sample covered with bio, attempt failed	
16:04:09	tainkg the shovel for taking a rocks sample	
16:11:54	HDTV On, tin-panning for rocks	
16:12:15	taking rock fragments with shovel; surface covered with bio; placing into plastic box	52 ROV-12
16:13:19	HDTV Off	HDTV ATA-52ROV_11
	taking a second rock sample with shovel, surface covered with bio; placing into plastic box; same	
16:28:21	sample numer	
16:35:26	attempt to place a bio net as marker;	52 ROV-13
16:47:52	taking the Ti Majors which was lost from porch during operation for rock sampling	
16:52:29	HDTV On, lookng for somewhere to drop net	
16:57:35	HDTV Off	HDTV ATA-52ROV_12
17:00:56	HDTV On, bionet on seafloor	
17:01:14	placing the bio net as marker; marker gets a sample number	52 ROV-13
20.01.2008 17:02	HD off	HDTV ATA-52ROV_13
	17:03:44 sampling location was on the eastern flank of a fissure; a sheet flow is visible not covered with mussels	
	attempt to fly some 100 meters in the direction of "Sisters Peak"; 350° heading; some 100 meters with	
	17:03:51 the aim to find to sisters peak	
	17:07:23 lobate flow associated with sheet flow	
20.01.2008 17:07	HD on, for the whole flight N across lava looking for Sister's Peak	
17:10:28	80 m from start of traverse	
17:11:24	very massive flow of lobates/pillows without bio	
17:13:51	water seems to get smoky	
17:14:15	looking around if smokers are visible	
17:17:07	big sediment carpet	
17:17:33	HDTV Off	
17:17:20	HDTV On, more flight over seafloor and looking for S.P.	
17:19:24	HDTV Off	HDTV ATA-52ROV_14
17:20:08	end of dive	HDTV ATA-52ROV_15

Cruise Number Atalante Leg 2
Station Number 57ROV
Dive Number #19
Location Turtle Pits#3
Coordinates 4°48,558' S 12°22.463' W
Water Depth 2989m
Vessel Atalante

Metadata
 Timecode
 default

Observation
 allowed

Actions
 allowed

9:00:00 Begin Station
 9:36:00 ROV in Water
 11:03:43 Bottom sighting
 11:14:35 ABE dive weight
 11:19:27 Turtle Pits
 11:24:14 A smoker is visible, not clear which one it is.
 11:30:34 AT southern tower, making HD film as some bubbles coming out
 11:34:33 Looks like venting vapour on side of southern Tower
 11:37:00 HD did not want to work
 11:37:31 Moving to Two Boats
 11:40:38 Slowly moving to Two Boats
 11:42:17 Marker 2 found
 11:43:11 HD On, flying around Two Boats
 11:48:18 HD Off
 11:55:27 HD On, landing base of Two Boats
 11:56:07 HD Off
 11:59:29 HD On, base of Two Boats
 12:00:19 HD Off
 12:03:40 HD On, shrimps and fluid at base of Two Boats
 12:04:57 want to measure temp.
 12:05:15 HD off
 12:05:36 HD On, small smoker with shrimps
 12:05:56 HD Off
 12:06:48 HD On, more small shrimp on smoker
 12:07:19 HD Off
 12:11:44 HD On, shrimps and the end of something, smoke in bkgnd
 12:13:00 HD Off
 12:14:01 Temperature: 334, 370, not hot enough, the vent also does not look very active
 12:16:27 Deciding where to go
 12:28:45 HD on, fly round top of smoker
 12:29:10 HD Off
 12:32:23 ROV touched smoker
 12:49:33 HD On, lots of prop. Wash on top of smoker
 12:52:06 HD Off
 12:54:03 Want to approach smoker with Rig Master extended
 12:59:26 Trying at base of Tower
 13:01:35 Landed on SE base of Southern Tower, looks hopeful but is difficult to get to.
 13:13:12 taking KIPS for T-measurement; measurement failed
 13:19:06 still looking for a good place
 13:20:48 HD on, flight around base of Southern Tower
 21.01.2008 13:23 HD off
 13:23:00 HD On, top of smoker
 13:23:31 HD Off
 13:34:09 Taking a large sample from chimney with Riggmaster, placing on porch
 13:39:00 HD On, smoke at top of smoker
 13:39:51 HD off
 13:55:37 HD on, approach to base of smoker
 13:57:18 HD off
 14:10:42 taking KIPS for T-measurement
 14:17:42 stop of the attempt to measure Temp..
 21.01.2008 14:25 HD on, Two Boats from a distance
 14:26:50 HD off
 14:26:00 HD On, another flight to Two Boats?
 14:27:10 HD Off
 14:32:20 proceeding to two boats, attempt to measure temp
 14:35:00 HD On, rigmaster on smoker outlet
 14:35:36 HD Off
 14:36:02 now trying to make a vent with rig master
 14:41:59 still working with rig master on two boats
 14:48:04 several attempts to get a temp reading from a vent
 14:52:39 Tmax currently at 200°C
 14:55:43 relocating ROV to new position at two boats vent
 15:03:32 still cruising
 15:07:56 irrespective of the temperature reading to come, sampling will go ahead now
 T max now 340°C though opening small, vent openings apparently are very dynamic, they close and
 open in a day or two
 15:18:17 try to make 340°C vent bigger
 15:23:21 another KIPS deployment still at Two Boats
 15:32:03 T measurements in the range of 270 to 370°C
 15:35:56 pumps on filling bottle C9
 measured T is about 220°C however, nozzle is placed more directly above discharging fluid so that
 15:36:56 fluid sample temperatures are probably higher
 15:39:24 pumps off
 15:39:44 pumps on filling bottle C8
 15:42:31 pumps off
 15:43:06 pumps on filling bottle C7
 15:46:17 pumps off
 15:46:46 pumps on filling bottle B6
 15:50:02 pumps off
 15:52:03 next deployment: IB sampler
 15:58:53 still working on putting KIPS in garage...
 16:03:35 KIPS in garage. ROV 20 m off the ground

HDTV ATA-57ROV_1

HDTV ATA-57ROV_2

HDTV ATA-57ROV_3

HDTV ATA-57ROV_4

HDTV ATA-57ROV_5 (note times wrong on video)

HDTV ATA-57ROV_6 (note times wrong on video)

HDTV ATA-57ROV_7 (note times wrong on video)

HDTV ATA-57ROV_8 (note times wrong on video)

HDTV ATA-57ROV_9 (note times wrong on video)

HDTV ATA-57ROV_10 (note times wrong on video)

HDTV ATA-57ROV_11 (times wrong)

ATA-57ROV-1

HDTV ATA-57ROV_12 (times wrong)

HDTV ATA-57ROV_13 (times wrong)

HDTV ATA-57ROV_14 (times wrong)

HDTV ATA-57ROV_15 (times wrong)

HDTV ATA-57ROV_16 (times wrong)

ATA-57ROV-2

ATA-57ROV-3

ATA-57ROV-4

ATA-57ROV-5

16:07:13 landing on sheet flow, lightly sedimented
16:08:09 great striations!
16:10:29 still sheet flow
no more communication to ROV container. Walkie-Talkie stopped working for some non apparent
16:11:05 reason. Difficult to relocate Turtle Pits. No beacon reading. Trying to locate using Posidonia.
16:14:50 Dead mussels
16:16:51 beacon found
16:20:02 sheet flow agin
16:24:49 back at Turtle Pits, Two Boats
16:35:59 next deployment: IB sampler
16:47:22 IB sampler opened
16:48:00 HD On, IB Sampler sampling
16:48:33 HD Off
16:49:49 HD was on for IB sampling
16:50:59 HD on, trying to close He tube with Orion
16:51:51 HD off
17:01:08 IB sampler closed
17:14:13 Major D2 is next
17:34:32 could not be released
17:42:06 try again
17:54:17 Major D2 released by error, no sample
18:06:20 stowing IB sampler
18:32:11 Beacon 11 found and collected
18:36:28 next target: Wideawake beacon
crossing from jumbled flow to sedimented lobate flow (mapped as "old flow" in ABE volcanological
18:38:41 interpretation by C.Devey)
18:46:46 beacon found even without signal
18:52:47 Attempt to take mussels with bionet
19:01:09 chnage of plan: First beacon 10 placed on poarch
19:01:32 now start of biosampling
19:04:29 bionet "J" fallen out of Orion into sample box
19:07:00 "it is one of these f...ing stupid days..."
19:09:17 bionet in Orion!
19:12:31 mussels in bionet!
19:13:20 HD On, mussel net with Orion
19:13:58 more mussels
19:14:12 bionet in big sample box
19:18:39 HD Off
19:22:52 manipulating beacon in order to ensure its fixed position
19:26:44 beacon fixed. Rigmaster bings in second beacon.
19:29:31 leaving ground

ATA-57 ROV-6

HDTV ATA-57ROV_17 (times wrong)

HDTV ATA-57ROV_18 (times wrong)

ATA-57ROV-7

HDTV ATA-57ROV_19 (times wrong)

Cruise Number Atalante Leg 2
Station Number 63 ROV
Dive Number #20
Location Inside Corner High #2
Coordinates 5°05.848'S 11°40.429'W
Water Depth 2400m
Vessel Atalante

Metadata	Observation	Actions
Timecode default	allowed	allowed
	8:50:00 Begin Station	
	9:00:00 ROV in Water	
	9:52:14 ROV Descent stop at 1130m	
	10:10:07 ROV descends. 1562m	
	10:22:48 2000m	
	10:34:16 Wand in sonar zu sehen in 40m entfernung	
	10:34:40 Bottom sighting, sediment and small stones 20m W of steep wall	
	10:38:54 boulder field	
	10:41:15 No sign of steep wall! Sonar picture probably just this boulder field	
	10:42:13 Looking for steep wall.	
	10:43:33 Probably 150m north of steep wall from dive#1 according to map	
	10:44:04 5°05.798 11°40.368 are ROV coords, 2489m depth, going south	
	10:46:18 Something on sonar in 30m distance	
	10:47:26 HDTV On, talus blocks with sed cover	HDTV ATA-63ROV_1
	10:48:19 Looking at rocks, trying for an interpretation	
	10:49:25 Interpretation difficult due to sediment	
	10:51:39 HDTV Off	
	10:51:53 Climbing wall slowly	
	10:52:19 Vertical crack - fault or joint	
	10:52:31 HDTV On, joint may be cliff face, dips 70° to E 2476m	
	10:53:39 Strong jointing 70°E, internal Strukturen dip 30° to W	HDTV ATA-63ROV_2
	10:54:31 A Ruschel-Zone	
	10:55:01 Going to try sampling	
	10:55:38 HDTV Off	
	10:56:10 Deploying Rigmaster	
	10:58:00 HDTV On, massive rock wall	
	10:59:21 Attempting sampling, looks very broken, lozenge-shaped pieces	HDTV ATA-63ROV_3
	10:59:43 HDTV Off	
	11:01:59 Still trying	
	11:02:27 Not sure whether tectonics or rock-type responsible for the look of this rock	
	11:06:05 Going to try to put porch on	
	11:07:51 Docked!	
	11:11:24 Rocks keep falling down between porch and wall!	
	11:12:57 A good day for Dan, a bad day for a rock (and one giant leap for mankind) 5° 05.854 11°40.356 2472m rock on porch, sample in-situ	ATA-63ROV-1
	11:15:45 Klüftung 70° in den Hang, nach W	
	11:16:00 HD On	
	11:16:29 Thinly bedded/jointed	HDTV ATA-63ROV_4
	11:16:46 HD Off	
	11:16:51 HD On	
	11:17:03 Thinly-banked units, jointed dipping steeply W	HDTV ATA-63ROV_5
	11:18:21 The thick banks have disappeared, looks much more broken. It is tectonic effect	
	11:19:26 HD Off	
	11:20:01 Looking West onto the short end of the eastward-dipping blocks	
	11:20:29 The cliff is tectonic surface, not just a landslide surface	
	11:20:47 HD On	
	11:21:22 Joint surfaces well seen dipping 70° into cliffs	HDTV ATA-63ROV_6
	11:21:56 HD Off	
	11:23:14 HD On	
	11:23:40 On E-W striking wall, see two joint systems, one dipping steeply to W, one slightly shallower to E	
	11:24:40 Attempting another sampling	HDTV ATA-63ROV_7
	11:24:53 HD Off	
	11:26:42 Sampling attempt, dropped in the slips	
	11:29:56 Trying again, huge piece 5° 5.863 11°40.369 2430m	ATA-63ROV-2
	11:32:59 Wall strikes 300° in sonar The structure which we have been calling joints dipping W looks irregular and like banking - magmatic contracts/Layering??	
	11:35:30	
	11:36:54 Small step, in 10m it continues	
	11:37:43 Going over step	
	11:38:49 Stripes on rock probably sediment	
	11:41:01 Wall strike 315°	
	11:41:14 HD On	
	11:42:35 Want to go W to try and find another wall orientation, we appear to be climbing a joint surface	HDTV ATA-63ROV_8
	11:42:56 HD Off	
	11:43:33 Corner of wall, can look from both sides	
	11:44:03 HD On	
	11:44:22 Lots of structures dipping to east	
	11:45:11 Already ascended 130m wall	HDTV ATA-63ROV_9
	11:45:54 Joint system dipping 70° to E is clearly visible	
	11:46:14 HD Off	
	11:46:55 HD On	
	11:47:03 Lots of tectonic L, to right a big joint	HDTV ATA-63ROV_10
	11:47:31 HD Off	
	11:47:36 Heavily tectonised possible fault surface	
	11:48:59 Wall strikes 300° in sonar	
	11:50:09 Vertical movement surfaces visible, harnisch is the word which is being banded about	
	11:52:02 Still on wall	
	11:52:38 Moving to SE to try and get another viewing angle	
	11:53:54 Heavily colonised surface	
	11:54:18 Traversing slope to see what is going on	
	11:55:16 HDTV On	
	11:56:27 HDTV Off	HDTV ATA-63ROV_11
	11:55:45 IN small talus pile, looking for a piece to take	
	11:56:33 Sampling attempt, putting in drawer, box 2	
	12:01:49 5°05.919 11°40.382 2324m	ATA-63ROV-3
	12:04:57 Sonar shows no hard echos, looks more like talus slope	
	12:06:24 Found a solid face, ascending	
	12:08:25 ON broken surface, hoping to see some structure when the surface is continuously breaking	
	12:10:51 Many more small blocks here, may be different rock although in container does not look like it	
	12:14:05 HD On	
	12:14:53 HD Off	HDTV ATA-63ROV_12
	12:14:59 Steep slope in front of ROV, possibly parallel to dip direction	

12:15:38 ROV oriented 300° to find that wall
12:16:21 Possibly end of wall, sample attempt
12:17:14 HD On, approach for sampling
12:18:06 HD Off
12:19:40 Grabbed, will it fit in drawer?
12:20:56 5 05.927 11 40.433 2265m, box 3
12:22:31 Vehicle still positively buoyant
12:23:59 Talus slope
12:24:33 Top of slope or talus pile. Sonar is also less clear. The big wall is visible on sonar behind through
12:28:21 Basic topo map no good in this terrain
12:29:49 Still on talus slope
12:31:40 HD On
12:31:41 Xenolith in gabbro??
12:32:58 May be a surface covering, not a xeno though
12:33:38 HD Off
12:35:24 Joints steep, dipping to NW
12:39:05 Rocks more rounded, more sediment and animals - slope older?
12:39:41 Sonar picture is diffuse, no wall visible, probably talus + seds.
12:40:27 Moving N looking for wall
12:43:26 On a wall again, now looking 214°
12:44:29 Looking for a place to take a sample
12:45:16 Massive rock wall
12:45:30 HD On
12:46:19 Pentagon scalöe bar
12:46:34 HD Off
12:47:22 ON bottom, starting sampling
12:48:19 Difficult to grab anything
12:49:05 5°05.934'S 11°40.527'W 2175m, let's see if we get a sample
12:51:22 5°05.931' 11°40.527' 2175m have a sample now, in box 2 closer to ROV
12:57:08 Still on blocky talus, moderately sedimented
Solid wall, still gabbro, less jointing (perhaps reason for old talus, or we are looking at main joint surface)
12:58:09
12:59:31 Now more broken
13:01:15 Main fault surface, dipping east
13:02:50 passing through another "Ruschelzone" 2130 m
13:03:31 Changing course in order to gain another view on the western cliff face
13:05:26 looking on western face of cliff, blocky scree
13:08:14 ROV pilot shift change
13:09:43 progressing up the hill. 2113m
13:10:00 passing plastic bag? NO. Its a "Fächerkoralle". On scree slope.
13:11:30 Facing 320. Blocky scree slope.
13:12:37 Blocky outcrop. 2106m
13:15:01 scree slope. Sediment. 2092m
13:16:29 climbing scree slope, platy blocks.
13:17:57 ROV still facing W: 246
Looks like a good spot to take another sample. Also, sonar indicates that steep slope may terminate a little further up.
13:19:19
13:25:59 Sample in Orion. Placed in box 1 next to shovel. 5°5.968'S 11°40.583'W. 2082m
13:29:12 NOTE for the ROV Weight Watchers: After this sample the ROV has no more Buoyancy.
After an area dominated by rounded blocks we are back in area with blocks/slabby scree. ROV still travelling westward.
13:30:21
13:31:26 passing over in-situ outcrop.
13:32:19 HD on. In order to document the structures in this upper region.
13:33:56 ROV parallel to main thrust plain which is striking 300. 2065m
13:35:17 HD off.
13:36:18 Steep nose ahead. Travelling up this outcrop. Little sediment cover. Abundant Gorgonaria.
13:41:39 HD on.
13:42:32 HD off
steep cliff ahead. Climbing steeply facing massive rock outcrop. Strike 330. Rock type: gabbro.
13:43:15 2015m
13:46:23 Still climbing vertically. 1996m
13:46:48 Reaching blocky scree slope. Abundant sediment.
Reached top of 20m high cliff. Terrace covered with blocky scree. Looks like in-situ material. Good opportunity to look for a sampling spot.
13:47:48
13:51:33 HD on and off.
13:53:52 passing over in-situ outcrop and in-situ blocky breccia.
13:55:19 Found a good spot for sampling
13:57:42 Sample in Orion claw. Dropped.
13:58:39 sample in Orion claw. Too big => dropped.
14:01:40 Suitable rock found. 5°6.022'S 11°40.698'W 1978m Placed in big sample box. Middle position.
14:05:40 Travelling S in order to return to the old track followed before towards waypoint 3.
14:11:15 Strongly sedimented boulder slope. Reached track. Heading upwards.
14:12:10 1945m 5°5.987'S 11°40.775'W
14:14:57 Climbing steep cliff face. Joints running ~N-S.
14:15:54 Strongly sedimented blocky boulder slope.
14:16:36 Back in steep rocky outcrop face. Heading 217
14:19:41 Found suitable sampling location.
14:22:23 Orion deployed
14:22:51 HD on
14:24:52 HD off
14:25:11 Sample with Hydrozoa shaft. 5°6.013'S 11°40.817'W 1876m Sample in box 3.
14:30:44 Traveling across blocky boulder field. Sedimented. Heading 218
14:33:41 Blocky outcrops. Huge slabby blocks, lightly sedimented.
14:35:51 1810m. Heading 236
14:38:35 Morphology: Steeply terraced terrain.
14:40:08 just a joint... ROV facing 180. 1782m
In this area the slope is striking N-S with little opportunity to investigate the inner structures (i.e., looking at E-W oriented outcrop faces)
14:41:49
14:42:58 Looking for suitable sampling spot. However this is rather steep rocky terrain.
14:45:15 HD on
14:45:33 HD off
14:46:10 HD on
14:47:12 HD off
14:49:48 Orion deployed but this site is not quite suitable.
14:54:30 HD on targeting new sampling site.
14:55:30 HD off
14:56:44 Sampling successful at new site. 5°6.059'S 11°40.843'W 1767m
14:58:01 shift change of ROV pilots
14:58:59 Leaving sampling site in order to put rock sample in a save place on the ROV.
15:01:56 Sample placed in big sample box. On the Orion side of sample ROV-7 (below IB sampler)
300° striking cliff surface ahead. Orientation unchanged. Seems peculiar since ridge axis is striking
15:04:04 at 330°
15:04:06 HD on, fish
15:04:19 HD off
15:04:42 strongly sedimented terrace. We are travelling westward.
15:05:45 boulder field with sediment
15:07:42 slope is dipping with 30°, sediment covered
15:08:29 approaching a steep wall, the cliff face is striking North-South

HDTV ATA-63ROV_13

ATA-63ROV-4

HDTV ATA-63ROV_14

HDTV ATA-63ROV_15

ATA-63ROV-5

ATA-63ROV-6

HDTV ATA-63ROV_16

HDTV ATA-63ROV_17

HDTV ATA-63ROV_18

ATA-63ROV-7

HDTV ATA-63ROV_19
ATA-63ROV-8

HDTV ATA-63ROV_20

HDTV ATA-63ROV_21

HDTV ATA-63ROV_22

ATA-63ROV-9

HDTV ATA-63ROV_23

15:10:21 climbing up

15:11:48 surface is covered with sediment and rock debris

15:14:29 big blocky debris on sediment covered surface

15:17:12 searching for a place to park and collect a rock sample

15:18:12 HD on

15:18:30 rocks look more tectonized than previous exposures

15:19:32 HD off

15:25:58 sampling: 5°6.081 S, 12°40.949 W, 1673.8 m, sample placed in drawer in box 2, on top of everything in the back of this box

15:32:22 continue up the steep slope

15:34:46 HD on

15:34:53 surface of rocks look darker in comparison to further down, may be even the fresh material is darker, rocks slap more flat

15:35:55 HD off

15:40:14 black rock sample with white dots (two pieces) in box3 at 5°06.089S 11°40.982W, 1636m

15:48:26 HD on

15:49:31 HD off

15:50:47 Dip of the rocks appears to have changed. Was 70° below.
The little valley in front has steep flanks. This may be one of the corrugated streaks? Valley is 16 wide and 18 m at its deepest point. The valley is horseshoe shaped. Strike: 260. However, the corrated streaks visible in bathymetric maps are in 100 meters dimensions (each pixel is about 200m). Maybe this is a smaller scale version not detectable in bathymetric maps?

15:51:09 HD on. There are differences in structure. 1603m

15:57:16 HD off.

15:58:45 Steep rocky outcrop. No sediment. Facing 270. Streaky vertical structures.

16:00:09 HD on. The rock face is striking N-S. There are prominent slicken side structures! Dip is to steeply to the east.

16:01:22 1573m Sediment filled crack looks like whitish vein...

16:04:16 HD off.

16:05:04 HD on. Vertical view on shear zones. Dipping South to southwest.

16:05:19 HD off.

16:06:52 Still climbing wall strike is 10°; 60° dipping to the east. Which has a total height in the order of 30 to 40m

16:07:20 keep on climbing. 1541m. Cliff face heavily jointed.

16:09:57 Plan: Taking another sample...

16:12:24 HD on.

16:13:48 HD off

16:14:25 HD On

16:15:00 Trying to take sample here.

16:15:05 HD Off

16:15:33 too difficult. Moving to a different spot.

16:20:54 The rocks look massive with some jointing. Looks like blocky to columnar jointing.

16:24:34 HD On

16:25:00 HD Off

16:25:39 Moving to yet another site.

16:26:35 Still having problems with sampling.

16:31:05 Sample in Orion claw.

16:32:43 5°6.104'S 11°41.061'W. 1521m. Placed on top of box1.

16:34:02 This location here is about 100 m to the north of the planned waypoint 3. The terrain is still very steep. Plan: Continue straight to the west to reach top of inside corner high structure.

16:38:19 HD on

16:39:12 HD off

16:39:58 Climbing to 1510m Facing 270. Moving along surface.

16:40:50 Changing position facing 210. Steep rocky black surfaces.

16:42:18 HD on

16:43:25 Abundant corals. Looking at SW striking flank.

16:43:33 Blocky rocky scree.

16:44:15 HD off

16:45:39 1493m

16:46:10 It is getting more shallow and the rock character has changed. The black rocky scree is sedimented and abundant deep sea corals.

16:46:28 SHARK! HD movie.

16:50:04 HD Off

16:50:42 Reached plateau at 1489 m

16:50:20 Taking sample.

16:50:39 5°6.118'S 11°41.102'W 1491m Sample with intense Mn crusting.

16:52:28 HD on, nice sampling shot!

16:53:11 HD off

16:54:08 Fist sized, knobby sample placed in big sampling compartment. Apparently the other samples have moved around...

16:54:48 flat sedimented area, top of escarpment reached

17:06:12 move north now

17:06:50 try to reach the cliff face again, searching for a less sedimented area

17:08:09 steep slope down in front, turn west to search for cliff

17:09:14 wall appears in sonar to the west

17:09:58 reached the wall, moving up

17:10:26 HD On

17:11:45 investigated a vertical structure, more massive to the left, more structured to the right

17:12:27 HD Off. looks like a sediment debris flow (HD on for short time)

17:13:17 HD on

17:13:32 narrowly spaced exhumation (tectonized) streaks

17:14:29 strongly tectonized area, trying to collect sample

17:15:30 HD off

17:15:30 sampling: 5°6.093 S, 11°41.125 W, 1529 m, small triangular sample placed in drawer in box 1, next to shovel

17:18:11 sample is pervasively sheared material

17:21:42 HD on

17:21:58 slope is dipping at shallow angle

17:22:27 HD off

17:24:35 almost reached the top at 1497 m, looking for final sample

17:24:48 reached the top, searching for a parking lot in order to sample

17:25:56 sampling at 5°6.116 S, 11°41.101 W, 1492 m

17:26:25 sample placed at the left corner of the porch

17:30:33 ROV is leaving the bottom. (almost) on time!

HDTV ATA-63ROV_24

ATA 63 ROV-10

HDTV ATA-63ROV_25

ATA 63 ROV-11

HDTV ATA-63ROV_26

HDTV ATA-63ROV_27

HDTV ATA-63ROV_28

HDTV ATA-63ROV_29

HDTV ATA-63ROV_30

HDTV ATA-63ROV_31

HDTV ATA-63ROV_32

ATA-63ROV-12

HDTV ATA-63ROV_33

HDTV ATA-63ROV_34

HDTV ATA-63ROV_35

ATA-63ROV-13

HDTV ATA-63ROV_36

HDTV ATA-63ROV_37

ATA 63ROV-14

HDTV ATA-63ROV_38

ATA 63 ROV-15

Cruise Number Atalante Leg 2
Station Number 67ROV
Dive Number #21
Location Red Lion
Coordinates 4°48.661S 12°22.606
Water Depth 2995
Vessel Atalante

Metadata	Observation	Actions
Timecode default	allowed	allowed

Begin Station
 9:20:00 ROV in Water
 9:30:00 Coordinates wrong in plan, need to move ship 1 mile N
 9:51:41 Fahrleiter not very happy with himself
 11:40:37 2966m depth approaching target
 11:42:31 bottom contact for ROV
 11:47:08 4°47.821/12°22.641 at depth of 3048 m
 11:47:43 hackly to pillow flow transition here
 11:48:22 Posidonia tells us that ROV direct west of smoker
 11:50:10 Proceeding towards east. Aim: locating Red Lion
 11:54:30 FOUND smoker! Shrimp Farm. NO shrimp. Apparently no hydrothermal activity.
 11:55:06 HD on, Shrimp farm
 11:55:47 4°47.822'S 12°22.602'W 3040m
 11:59:55 Proceeding towards Tannenbaum smoker
 12:00:17 Pillows are intensely covered by hydrothermal sediment
 Tannenbaum located, Mephisto visible in the distance. Tannenbaum still actively discharging black fluids from its top. Vigorous.. No shrimp. No apparent biological colonization. Ca. 5m high including
 12:01:41 foot hill of sulfide talus.
 12:02:53 HDTV Off
 12:02:54 HDTV On Tannenbaum
 12:04:44 HDTV Off
 Mephisto located. Hydrothermal discharge at top, three small orifices. Discharge appears reduced compared to last years observations. Also the colonization by shrip is substantially reduced. Only
 12:05:43 some white, shrimp patches on the to region.
 12:05:50 HD On
 12:07:42 HD Off
 12:07:54 HD ON
 12:09:21 HD Off
 12:10:05 preparing for video mapping
 12:12:25 start video mapping
 12:14:00 HD On
 12:14:10 HD Off
 12:15:21 HDTV crashed, start all over again
 12:17:06 start video mapping again
 12:26:39 HDTV circle at foot of structure completed, starting a similar round towards the top of the structure
 12:33:42 video mapping finished
 12:33:56 moving west to smoker structure that was visible in the back
 12:37:19 distance between Mephisto and Tannenbaum measured to be 8 m
 12:37:50 HD On
 12:38:20 HD on at Sugar Head
 12:39:40 shrimps almost gone from Sugar Head, moreover from the entire Red Lion field
 12:39:59 HD Off
 12:42:29 back at Mephisto, searching for landing spot
 12:44:50 HD On
 12:48:51 landing on top of structure
 12:48:59 HD Off
 12:50:51 start sampling for shrimp with slurp gun
 12:55:44 HD On
 12:55:59 HD Off
 12:57:52 left the ground...
 12:59:23 Back at Mephisto
 13:07:10 Still trying to slup shrimp while flying
 Difficulty is to find a suitable spot for landing and fixing the ROV. Slurping while flying is apparently
 13:11:41 not an option.
 13:13:59 ROV apparently fixed in the same position than previously, just before slup sampling initiated
 Slurping going on, apparently 1 or 2 shrimp caught + one carb! Sitting in Slup container 1. Caroussel
 13:15:27 turned to position 2.
 13:19:37 One shrimp is caught in the sample shamber.
 13:20:40 Trying to obtain samples while flying but there is apparently a lot of turbulence making flying difficult.
 Trying to suck shrim one by one... But there does not seem to be enough strength in the slurping.
 However, at least 2 shrimp have been caught. Sample in slurp container 2. Slurp gun container
 13:21:28 shifted to position 3.
 13:24:08 Slurp gun broken. T handle ripped off.
 13:28:54 ROV pilot shift change.
 13:32:14 next operation: Get fluid sample with Ti major.
 13:33:17 HD on. Nice picture

HDTV ATA-67ROV_1

HDTV ATA-67ROV_2

HDTV ATA-67ROV_3

HDTV ATA-67ROV_4

HDTV ATA-67ROV_6

HDTV ATA-67ROV_7

HDTV ATA-67ROV_8

ATA-67ROV-1

ATA-67ROV-2

13:34:10	HD off	HDTV ATA-67ROV_10
13:37:10	oil bubbles visible in slurp gun image	
13:39:06	slowly approaching top smokers	
13:39:15	HD On	HDTV ATA-67ROV_11
13:39:45	HD off nice picture of shimmering beehive	
13:41:32	New orifice open due to sudden beehive collapse.	
13:45:13	Plan: Fill Ti major bottles	
13:47:18	Ti major number D2 in Orion.	
13:49:42	HD on	HDTV ATA-67ROV_12
13:50:22	Placing Ti major nozzle in new orifice is difficult	
13:54:30	Ti major nozzle upright in orifice	
13:56:44	HD off	
14:01:05	Ti major release is difficult...	
	Technical note: ROV is loosing oil. Projected time left for diving: 3h 20 min. Priorities: Filling KIPS and	
14:05:56	locating oceanographic tools.	
14:07:54	Still working on releasing Ti major	
14:14:43	this Ti major bottle does not seem to be able to be released...	
14:15:30	Rigmaster comes to the rescue	
14:26:46	Ti major now held by Rigmaster, will be released with the Orion arm	
14:29:54	Ti major released, D2 sampled	ATA 67ROV-3
14:34:11	compensator pressure is at 50%	
14:36:20	placing Ti major in back part of the sample box	
14:39:36	HD on	HDTV ATA-67ROV_13
14:40:12	HD off	
14:44:42	sampling smaller chimney near to the big hole, believed to be more vigorously emanating	
14:46:31	measured T max is 340°C, 365°C	
14:48:17	pump on, filling bottle C9, clear fluid at exhaust	ATA 67 ROV-4
14:49:27	HD on	HDTV ATA-67ROV_14
14:51:46	pump off, then pump on	ATA 67 ROV-5
14:51:51	filling bottle C8, T stable at 363°C	
14:52:23	HD off	
14:54:29	pump off	
14:54:39	pump on, filling bottle C7	ATA 67 ROV-6
14:58:45	pump off	
14:58:58	pump on, filling bottle B6	ATA 67 ROV-7
15:03:14	pump off and on again, filling bottle B5, clear fluid coming out of exhaust	ATA 67 ROV-8
15:05:43	pump re-started for bottle B5	
15:07:37	pump off, KIPS sampling finished	
15:15:55	filling He tube at large orifice where beehive structure "collapsed" before	
15:17:12	He tube filled	ATA 67 ROV-9
15:19:13	compensator pressure is at 30% ! Coming up	
15:19:35	ROV off bottom	

Cruise Number Atalante Leg 2
Station Number 68ROV
Dive Number #22
Location NW of Comfortless Cove area
Coordinates 4°48.152'S 12°22.381'W
Water Depth 2995
Vessel Atalante

Metadata	Observation	Actions
Timecode default	allowed	allowed

Begin Station

17:17:15 U17r.U17r ROV in water. Starting dive to recover oceanographic tool.

17:20:57 U17r.U17r No Posidonia???

17:26:00 U17r.U17r Posidonia Si, oui, JA.

17:26:21 U17r.U17r 350m

18:32:27 U18r.U18r bottom recognized with ROV sonar

18:33:16 U18r.U18r bottom visible, depth 3002 m, position 4°48.090'S and 12°22.384'W

18:36:38 U18r.U18r ROV over pillow lavas with plenty of sediment filling in between, searching for mooring

18:39:44 U18r.U18r ROV flies 270

18:40:12 U18r.U18r jumbled flow with no sediment, i.e. Is younger

18:42:58 U18r.U18r course now 295

18:43:32 U18r.U18r now at predicted mooring location

18:44:09 U18r.U18r heading bit north, heavily jumbled flow, hummocky terrane

18:46:17 U18r.U18r 4°48.098'S and 12°22.451'W

18:47:53 U18r.U18r now checking terrane in south, heavily jumbled, hummocky terrane, bit sediment

18:50:03 U18r.U18r proceeding south

18:50:35 U18r.U18r 4°48.136 and 12°22.432 entering pillow terrane, pillows are above jumbled flow!

18:52:19 U18r.U18r heading east, jumbled terrane with sediment

18:52:55 U18r.U18r now pillows with sed with initial transitions to tubular flow

18:56:35 U18r.U18r heading north

18:57:40 U18r.U18r heading west 12°22.405W and 4 48.110'S

18:58:35 U18r.U18r jumbled flow no sed
12°22.458'W and 4°48.119'S marks contact of jumbled flow against pillow, pillow appears younger,

19:02:23 U19r.U19r however, pillowed flows has more sediment....

19:06:38 U19r.U19r 12°22.470'W 4°48.132'S jumbled flow

19:10:46 U19r.U19r continue to head east

19:13:22 U19r.U19r 12°22.427 and 4°48.098'S, contact jumbled (so far) into pillow

19:15:41 U19r.U19r pillows with abundant collapse structures

19:18:09 U19r.U19r 12°22.405 and 4°48.104'S, turning south

19:19:53 U19r.U19r heading west 4°48.109 and 12°22.403 pillows with sediment

19:22:11 U19r.U19r all jumbled now with no sediment
perhaps lobate at tip transitional to pillow, only lobate can collapse to form jumbled, thus jumbled against pillows, both have same age

19:26:38 U19r.U19r continue west in jumbled flows

19:30:31 U19r.U19r 12°22.472'W and 4°48.1109 S, heading south

19:30:54 U19r.U19r now into pillows then into jumbled

19:32:59 U19r.U19r 12°22.467'W and 48.116°S heading E

19:33:49 U19r.U19r still jumbled

19:36:29 U19r.U19r heading north 12.22.433'W and 4°48.097'S

19:38:12 U19r.U19r heading east 12.22.432 and 4.48.096'S

19:39:04 U19r.U19r contact to Pillow flow marked by lobate structures

19:39:51 U19r.U19r big pillows

19:40:59 U19r.U19r looking around. Pillows everywhere

19:42:11 U19r.U19r 22.412W 48.087S Pillows

19:43:35 U19r.U19r Turned back W. Crossing over into jumbled flow.

19:48:13 U19r.U19r jumbled flow heading W

19:53:57 U19r.U19r No Posidonia readings. Turning back east.

19:54:44 U19r.U19r still jumbled flow
Crossing into lobate flow overlying jumbled flow to the east. However, as usual this lobate to pillowed flow appears to be more strongly covered by sediment than the jumbled flow. Still it is lying on top of it...

19:59:19 U19r.U19r moving upwards, 3004m This is a pillow mound.

20:03:23 U20r.U20r Turning around. Pillows everywhere. 3004m

20:04:54 U20r.U20r 22.417'W 48.068'S Pillows

20:10:15 U20r.U20r Heading West

20:10:36 U20r.U20r Back in jumbled flow

20:10:47 U20r.U20r Rather: contact zone between lobate flow structures and jumbled flow.

20:11:30 U20r.U20r Heading further south over jumbled flow.

20:12:28 U20r.U20r 22.439'W 48.094'S jumbeld flow. 3006 m

20:14:20 U20r.U20r Heading west across jumbled flow

20:15:42 U20r.U20r jumbeld flow. 3008m. Still heading West.

20:18:06 U20r.U20r heading north

20:19:14 U20r.U20r jumbled flow. 3010m

20:21:30 U20r.U20r turning around. Jumbled flow everywhere.

20:23:25 U20r.U20r Jumbled flow. Steeplly hummocky terrain.

20:24:09 U20r.U20r Heading south.

20:26:02 U20r.U20r Heading east. Jumbled flow.

20:26:27 U20r.U20r Contact to lobate flow in the east appears. Clearly this is overlying the jumbled flow!

20:27:28 U20r.U20r Turning around. To the south: Jumbled flow.

20:28:21 U20r.U20r 22.451'W 48.072'S: Contact zone.

20:29:22 U20r.U20r Lobate to pillowed flow.

20:30:01 U20r.U20r Pillows. 3008m
22.421'W 48.067'S Pillow flow. Apparently the pillow flows are enclosing the jumbled flow to the north.

20:31:08 U20r.U20r north.

20:36:19 U20r.U20r Heading south.
20:36:47 U20r.U20r 22.417°W 48.084°S Pillows. 3005m,
20:38:46 U20r.U20r Turning around. To the west there is the transition to lobate flow.
20:39:53 U20r.U20r Heading south across pillows.
20:41:19 U20r.U20r 22.400°W 48.120°S Pillows. 3002m
20:44:56 U20r.U20r pillows
20:45:26 U20r.U20r Heading W crossing into jumbled flow
20:45:43 U20r.U20r jumbled flow. 3005m.
20:48:44 U20r.U20r 22.436°W 48.123°S jumbled flow. 3005 m
20:49:36 U20r.U20r heading west
20:51:20 U20r.U20r Crossing over contact: Lobate flow overlying jumbled flow. Lobate is about 1m thick at most.
20:54:06 U20r.U20r 22.480°W 48.127°S
20:55:31 U20r.U20r Heading south.
20:58:38 U20r.U20r heading north 22.472 and 4° 48.138S
20:59:14 U20r.U20r continue in jumbled flow
21:02:09 U21r.U21r 12°22.447°W 04°48.124°S heading east
21:02:58 U21r.U21r continue in jumbled flow, turning to 110°
21:07:00 U21r.U21r in pillows 22.408 and 48.116
21:09:15 U21r.U21r 22.393 and 48.113 turning W
21:10:33 U21r.U21r heading west in pillows
21:14:34 U21r.U21r 22.430 and 48.115 in jumbled flow continue west
21:19:57 U21r.U21r 22.450 and 48.116 break of search in jumbled flow
21:31:00 U21r.U21r abandoned attempt to get a nice piece of jumbled flow
21:34:07 U21r.U21r abandoned attempt to get a nice piece of jumbled flow
21:34:22 U21r.U21r ready for take off
21:36:55 U21r.U21r we have a lift off

Cruise Number Atalante Leg 2
Station Number 70ROV
Dive Number #23
Location 5°S Fracture Zone
Coordinates 4°56.420'S / 11°37.044
Water Depth 4765m
Vessel Atalante

Metadata	Observation	Actions
Timecode default	allowed	allowed

Begin Station
 10:45:00 ROV in Water
 13:04:39 at bottom, depth 4864 m!!, coordinates 11°36.987W 4°56.473S
 13:08:19 test have started, working with Orion arm
 13:16:38 one horizontal thruster seems dead as of 4300 m, possible water ingress
 video looks at our payload: painted styrofoam cups. The question is: will they be more compressed at
 13:17:12 this depth than before (at 3000 m)
 13:25:12 test start
 13:59:21 tests ongoing
 14:08:20 sediment on porch, drawer does not open, will try to wipe off with knife
 feedback problem with Orion, extra 180 bars starts causing more problems than hoped, thus problems
 14:09:22 getting knife out with Orion
 14:17:24 porch cleared with knife, but drawer still does not open
 14:19:52 drawer opens! Orion has still a feedback problem, operation thus difficult
 14:20:59 knife put back, this time into drawer
 14:33:08 ongoing tests of unknown nature
 14:42:33 a rock in the sediment
 15:06:22 attempt to deploy a marker; can be difficult, since the orion has problems
 15:11:43 Orion has still problems; delay in operation; moves very slowly and not accurate
 15:13:06 stop the attempt to work with Orion
 15:16:28 stop to work with Orion
 15:44:40 technical tests completed
 15:44:48 HD on
 15:47:02 Heading N
 15:48:34 HD off
 15:50:01 Sonar: big boulders ahead at about 30 m distance
 15:50:38 passing over sediment with occasional rocks
 15:51:53 rocky blocks and boulders partly covered by sediment. 4840m
 15:54:04 Proceeding to the N
 15:55:11 sediment
 15:55:38 Sonar: blocks in about 20 m distance
 15:56:22 reached foot of rocks boulder rising about 10 m from 4820m.
 15:58:59 Sonar: Boulder ahead.
 16:00:02 Heading N. Over sediment.
 16:00:50 4800. Sediment.
 16:02:20 ROV speed: ca. 1 km/h.
 16:03:12 4780m Sediment. Heading N.
 16:08:47 Located plastic water bottle on the seafloor sediment. 4772m
 16:10:24 Heading N. Reaching sedimented boulder.
 Climbing up steep E-W striking cliff face. Looks like in-situ outcrop. Plan: Take sample with Rigmaster
 16:11:13 (since Orion is out of action...)
 16:11:41 HD On
 16:13:55 HD has been on for a while in order to document the outcrop. 4760m. 4°56.347'S 11°37.055'W
 We may spend some time here since getting a sample from this deep outcrop would be important for
 16:18:49 comparison with the previous samples from shallower depths.
 Morphology of the outcrop surface looks distinctive from the previous dives. Knobbly texture suggests a
 16:21:44 serpentinitic lithology. However, maybe this is gabbro with a different type of weathering/alteration.
 16:24:37 Orion deployment. At least a try. However, movements are hardly controllable...
 16:31:01 Orion is catastrophic, parked and de-activated
 16:33:35 Rigmaster not good at this place,
 16:35:34 Rock looks massive but heavily jointed, probably Serpentinite
 16:36:04 HD On
 16:37:21 HD Off
 16:41:12 Attempting landing
 16:51:55 Attempting sampling 4°56.336'S 11°37.057'W 4753m
 Sample taken, hopefully it will go on porch. Crumbled and just fell on porch, front right position on the
 16:53:37 porch, in front of Orion
 17:02:28 crumbly piece of rock, totally different from inside corner high, could be serpentinite
 17:13:22 HD on, rocks look more and more like serpentinite
 17:14:21 HD off
 17:16:01 climbing up heading N, rocky boulders and sediments. 4710m
 17:17:21 approaching steep cliff
 17:17:54 HD On
 17:18:01 60° dipping, N-S striking fractures.
 17:19:01 HD off, has been on for a while.
 17:20:02 4690m
 17:21:01 HD on. Investigating vertical structure. May be just a feature due to particular sediment cover
 17:22:27 HD off. The structure is due to sediment dripping down a rock face.
 Climbing up passing blocky boulders and sediment covered slopes. Rock still look similar to the lithology
 17:26:49 sampled below.
 17:27:46 HD on.

HDTV ATA-70ROV_1

HDTV ATA-70ROV_2

HDTV ATA-70ROV_3

ATA-70ROV-1

HDTV ATA-70ROV_4

HDTV ATA-70ROV_5

HDTV ATA-70ROV_6

17:27:59 Blocks present may be different types of lithologies. Investigating some whitish looking blocks. HDTV ATA-70ROV_7

17:29:09 HD off. White block may be solidified sediment tumbled down from above.

17:29:39 The knobby rock type appears to be mixed with more blocky to platy rock types.

17:30:58 Retrying Orion with one function disabled (6 of 7 working functions).

17:32:08 HD on

17:32:28 some blocks are banded HDTV ATA-70ROV_8

17:32:50 HD off.

17:37:22 Looking for parking spot in order to take a sample

17:41:40 Trying to work with Orion arm.

17:44:22 Difficult. Looking for other spot.

17:46:14 Reached steep nose-like rock cliff. Climbing up over sedimented boulder field. 4652 m. NO biology.

17:48:46 Found a new place for sampling operations.

17:51:20 "What a guy" Sample in Orion claw. Very elegantly done.

17:53:56 4°56.258'S 11°37.055'W 4654m ATA-70ROV-2

17:56:26 Placing dislodged Timajor bottle in big sampling box. So it is safely stowed now.

18:00:29 Based on morphology of the rocks there appear to be more blocky lithologies and more knobby rocks.
HD on. Strange breccia-like rock with white matrix. Rounded clasts (got rounded when rolling down this

18:01:32 slope). Internal layering visible. HDTV ATA-70ROV_9

18:02:36 HD off

18:03:14 climbing up. 4630m

18:04:10 Scree slope of rocky blocks. Little sediment cover. "Felsenmeer"

18:06:23 Probably formed as an avalanche deposit. This is a tectonically active zone!

18:06:58 Parking in order to take samples.

18:07:43 HD on. Pictures of "Felsenmeer"

18:08:14 HD off HDTV ATA-70ROV_10

whitish rock sample (strongly rounded) breaks apart under Orion claw. Foraminiferous Ooze? Placed in

18:11:10 Box 1. 4°56.231'S 11°37.073'W 4617m

18:15:26 Placed big platy block of Gabbro in the big sample box. Outside margin. ATA-70ROV-3

18:18:27 sediment and some boulders. 4605m Left "Felsenmeer" ATA-70ROV-4

18:20:25 Passing white rounded blocks and black platy blocks.

18:20:52 35° slope, strike 270 (E-W). Turning to get images of the slope that we have been traveling up.
Apparently we have moved up into different lithologies now. The earlier rock types below (serpentine) are no more present up here. Rather this looks like avalanche and scree deposits fed by gabbroic

18:22:34 lithologies further up slope.

18:23:56 "Hangschutt" deposits.

18:24:15 Passing possible in-situ cliff of gabbro?

18:26:37 Scree slope with sediment locally with apparently young, unsedimented blocky avalanche patches.

18:27:52 Climbing N. 4557m, sedimented scree slope.

18:28:41 occasional white block, rounded together with dark platy blocks

18:32:29 Step in the topo., looks like massive gabbro makes a small cliff

18:32:53 HD On

18:33:50 HD Off HDTV ATA-70ROV_11

18:42:12 4°56.145'S 11° 37.088'W 4515m ATA-70ROV_5

18:51:09 In situ, we will take a sample

18:51:35 HD On

18:52:59 HD Off HDTV ATA-70ROV_12

18:55:24 Landed, full of sed. Clouds

18:58:35 4°56.124'S 11°37.111'W 4468m. Sample taken and put on top of 1a

19:02:06 Large wall in front of us.

19:04:09 Going sideways to look at slope

19:10:27 Think we are still in gabbros

19:12:57 Big gabbro block

19:14:20 HD On

19:14:32 Heavily tectonised

19:15:11 Banded, bands dipping ca. 45° to E, start of cliff 4350m

19:16:14 HD Off

19:16:21 Going back down for sample, cliff is >20m high and vertical

19:19:42 HD On

19:20:52 Lava tube cut so that cooling joints visible, although Günter thinks it is a shear zone

19:21:09 HD Off HDTV ATA-70ROV_14

19:23:41 HD On

19:24:10 HD Off HDTV ATA-70ROV_15

19:27:17 Going to land, no sampling possible in hover

19:28:08 HD On

19:29:36 HD Off HDTV ATA-70ROV_16

19:32:29 No chance to take sample, going up

19:34:37 HD On

19:35:21 HD Off We see small intrusions with hyaloclastites around

19:37:02 HD On

19:38:50 OK; Günter may be correct, several zones with lineations dipping 45° to E.

19:39:30 HD Off

19:42:08 Going in again

19:44:17 Sample grabbed 4 56.046'S 11°37.131 4343m in Box 2

19:45:06 HD on

19:45:15 HD Off HDTV ATA-70ROV_17

19:46:52 Cliff strikes E-W, difficult to determine orientation of other structures

19:47:27 Schichten 50° nach SE einfallen, lineation is 20° on this

19:50:42 Still climbing up the cliff, 4310m Lithology unchanged.

19:52:32 Steep vertical cliff face. Some biology, occasional sediment dusting.

19:54:00 Reaching strongly sedimented portion of slope. 4295m Still rising steeply but with thick sediment cover.

19:54:53 4292m

19:56:00 Climbing steep cliff. 4289m HDTV ATA-70ROV_18

ATA-70ROV_7

HDTV ATA-70ROV_19

19:59:27 HD On
 20:00:18 Going to structure dipping to ESE
 20:01:48 HD Off
 20:02:46 Wall is vertical, the marks on wall dip to E and S, perhaps two ages of structures
 20:03:20 HD On
 20:04:20 HD Off
 20:06:46 Going in for sample
 20:09:31 HD On
 20:09:46 HD Off
 20:12:40 Sample grabbed 4 56.028 11 37.114 4252m taken on the fly, put in box 3
 20:13:00 HD On
 20:14:49 HD Off
 20:16:47 Break in slope, 4242 m depth
 20:20:42 Strike E-W, dip to S with 45°, clearly visible on sedimented slope
 20:22:03 Taking a sample, easy to get. But didn't work
 20:26:24 Joints dipping to W with 80°
 20:29:24 4 56.006° S 11°37.118 4218m sampling attempt
 20:31:20 HD On
 20:32:12 HD Off
 20:32:18 Seespinne (8 legs)
 20:34:11 Steep slope down to S
 20:37:11 Looks massive, lots of joints, not apparently fully deformed
 20:38:45 4 55.990 11 37.124 4175m, sample in box 2
 20:38:58 HD On
 20:39:14 HD Off
 20:40:58 HD On
 20:41:56 HD Off
 20:42:04 HD On
 20:42:14 Hyaloclastites in background E-W strike, 80° S dip
 20:42:51 HD Off
 20:43:35 HD On
 20:48:17 HD Off
 20:48:38 Steep wall again
 20:49:20 HD On
 20:49:54 HD Off
 20:51:27 Last sampling attempt
 20:51:35 HD On
 20:52:41 HD Off Even Jürgen and Günter think that this is volcanic!!
 20:53:29 Completely steep wall, different rock type
 20:54:08 HD ON
 20:55:06 HD Off
 20:56:57 HD On
 20:58:44 HD Off
 20:59:26 sonar shows a flat surface some 300 m above
 21:00:02 wall: strike 25°, dip SW 30° ???
 21:06:10 HD on for landscape pictures
 21:06:45 HD off
 21:07:43 planning to collect a sample
 21:13:58 collect a sample at: 4°55.983 S, 11°37.113 W, 4063m, placed in large box in the back
 21:21:31 HD on - fish
 21:22:09 HD off
 21:23:59 more sedimented somewhat flat area
 21:27:07 crossing a large flat surface, sediment covered, some blocks, looked more like gabbro
 21:30:05 depth is 4000m in contrast to existing map that shows 3900m
 21:30:51 again some rocks
 21:33:58 Strike E-W, dip to S with 25 to 30°
 21:37:21 collect a sample at: 4°55.895 S, 11°37.148 W, 3996m, angular+platy, placed in box 2
 21:43:34 steepness of the slope is increasing again which fits the topographic map
 21:45:26 HD on, rocks look more volcanic again
 21:46:42 HD off
 21:54:34 slope shows lots of sediment and debris flows/talus, no real outcrop for sampling
 21:58:58 HD on, looking for spot to sample
 22:00:15 collecting sample at: 4°55.816 S, 11°37.166 W, 3897m, placed in the back box, fist size
 22:03:04 HD off
 22:07:54 changing NNW, topographic map shows a high
 22:09:56 HD on
 22:10:34 HD off
 22:11:55 HD on
 22:12:23 HD off
 22:13:58 HD on
 22:16:55 HD off
 22:17:13 collecting a small sample of presumed serpentinite breccia, placed in the back box
 22:26:17 HD on
 22:26:58 HD off
 22:27:28 problems with thruster
 22:28:53 4° 55.765 S, 11° 37.201 W, 3825m (noted a few moments later)
 22:29:45 collecting another sample at 4°55.757 S, 11°37.212 W, 3815m, box 2, front part
 22:32:08 ROV leaving the bottom
 22:33:42 HD on
 22:34:16 HD off

HDTV ATA-70ROV_20

HDTV ATA-70ROV_21

HDTV ATA-70ROV_22
ATA-70ROV_8

HDTV ATA-70ROV_23

HDTV ATA-70ROV_24

ATA-70ROV_9

HDTV ATA-70ROV_25

HDTV ATA-70ROV_26

HDTV ATA-70ROV_27

HDTV ATA-70ROV_28

HDTV ATA-70ROV_29

HDTV ATA-70ROV_30

HDTV ATA-70ROV_31

HDTV ATA-70ROV_32

HDTV ATA-70ROV_33

ATA 70ROV-10

HDTV ATA-70ROV_34

ATA 70ROV-11

HDTV ATA-70ROV_35

ATA 70ROV-12
HDTV ATA-70ROV_36

HDTV ATA-70ROV_37

HDTV ATA-70ROV_38

HDTV ATA-70ROV_39
ATA 70ROV-13

HDTV ATA-70ROV_40

ATA 70ROV-14

HDTV ATA-70ROV_41

IFM-GEOMAR Reports

- | No. | Title |
|-----|---|
| 1 | RV Sonne Fahrtbericht / Cruise Report SO 176 & 179 MERAMEX I & II (Merapi Amphibious Experiment) 18.05.-01.06.04 & 16.09.-07.10.04. Ed. by Heidrun Kopp & Ernst R. Flueh, 2004, 206 pp.
In English |
| 2 | RV Sonne Fahrtbericht / Cruise Report SO 181 TIPTEQ (from The Incoming Plate to mega Thrust EarthQuakes) 06.12.2004.-26.02.2005. Ed. by Ernst R. Flueh & Ingo Grevemeyer, 2005, 533 pp.
In English |
| 3 | RV Poseidon Fahrtbericht / Cruise Report POS 316 Carbonate Mounds and Aphotic Corals in the NE-Atlantic 03.08.-17.08.2004. Ed. by Olaf Pfannkuche & Christine Utecht, 2005, 64 pp.
In English |
| 4 | RV Sonne Fahrtbericht / Cruise Report SO 177 - (Sino-German Cooperative Project, South China Sea: Distribution, Formation and Effect of Methane & Gas Hydrate on the Environment) 02.06.-20.07.2004. Ed. by Erwin Suess, Yongyang Huang, Nengyou Wu, Xiqu Han & Xin Su, 2005, 154 pp.
In English and Chinese |
| 5 | RV Sonne Fahrtbericht / Cruise Report SO 186 – GITEWS (German Indonesian Tsunami Early Warning System 28.10.-13.1.2005 & 15.11.-28.11.2005 & 07.01.-20.01.2006. Ed. by Ernst R. Flueh, Tilo Schoene & Wilhelm Weinrebe, 2006, 169 pp.
In English |
| 6 | RV Sonne Fahrtbericht / Cruise Report SO 186 -3 – SeaCause II, 26.02.-16.03.2006. Ed. by Heidrun Kopp & Ernst R. Flueh, 2006, 174 pp.
In English |
| 7 | RV Meteor, Fahrtbericht / Cruise Report M67/1 CHILE-MARGIN-SURVEY 20.02.-13.03.2006. Ed. by Wilhelm Weinrebe und Silke Schenk, 2006, 112 pp.
In English |
| 8 | RV Sonne Fahrtbericht / Cruise Report SO 190 - SINDBAD (Seismic and Geoacoustic Investigations Along The Sunda-Banda Arc Transition) 10.11.2006 - 24.12.2006. Ed. by Heidrun Kopp & Ernst R. Flueh, 2006, 193 pp.
In English |
| 9 | RV Sonne Fahrtbericht / Cruise Report SO 191 - New Vents "Puaretanga Hou" 11.01. - 23.03.2007. Ed. by Jörg Bialas, Jens Greinert, Peter Linke, Olaf Pfannkuche, 2007, 190 pp.
In English |

- | No. | Title |
|-----|--|
| 10 | FS ALKOR Fahrtbericht / Cruise Report AL 275 - Geobiological investigations and sampling of aphotic coral reef ecosystems in the NE-Skagerrak, 24.03. - 30.03.2006, Eds.: Andres Rüggeberg & Armin Form, 39 pp. In English |
| 11 | FS Sonne / Fahrtbericht / Cruise Report SO 192-1: MANGO: Marine Geoscientific Investigations on the Input and Output of the Kermadec Subduction Zone, 24.03. - 22.04.2007, Ernst Flüh & Heidrun Kopp, 127 pp.
In English |
| 12 | FS Maria S. Merian / Fahrtbericht / Cruise Report MSM 04-2: Seismic Wide-Angle Profiles, Fort-de-France – Fort-de-France, 03.01. - 19.01.2007, Ed.: Ernst Flüh, 45 pp.
In English |
| 13 | FS Sonne / Fahrtbericht / Cruise Report SO 193: MANIHIKI Temporal, Spatial, and Tectonic Evolution of Oceanic Plateaus, Suva/Fiji – Apia/Samoa 19.05. - 30.06.2007, Eds.: Reinhard Werner and Folkmar Hauff, 201 pp.
In English |
| 14 | FS Sonne / Fahrtbericht / Cruise Report SO195: TOTAL TONGA Thrust earthquake Asperity at Louisville Ridge, Suva/Fiji – Suva/Fiji 07.01. - 16.02.2008, Eds.: Ingo Grevemeyer & Ernst R. Flüh, 106 pp.
In English |
| 15 | RV Poseidon Fahrtbericht / Cruise Report P362-2: West Nile Delta Mud Volcanoes, Piräus – Heraklion 09.02. - 25.02.2008, Ed.: Thomas Feseker, 63 pp.
In English |
| 16 | RV Poseidon Fahrtbericht / Cruise Report P347: Mauritanian Upwelling and Mixing Process Study (MUMP), Las-Palmas - Las Palmas, 18.01. - 05.02.2007, Ed.: Marcus Dengler et al., 34 pp.
In English |
| 17 | FS Maria S. Merian Fahrtbericht / Cruise Report MSM 04-1: Meridional Overturning Variability Experiment (MOVE 2006), Fort de France – Fort de France, 02.12. - 21.12.2006, Ed.: Thomas J. Müller, 41 pp.
In English |
| 18 | FS Poseidon Fahrtbericht /Cruise Report P348: SOPRAN: Mauritanian Upwelling Study 2007, Las Palmas - Las Palmas, 08.02. - 26.02.2007, Ed.: Hermann W. Bange, 42 pp.
In English |
| 19 | R/V L'ATALANTE Fahrtbericht / Cruise Report IFM-GEOMAR-4: Circulation and Oxygen Distribution in the Tropical Atlantic, Mindelo/Cape Verde - Mindelo/Cape Verde, 23.02. - 15. 03.2008, Ed.: Peter Brandt, 65 pp.
In English |
| 20 | RRS JAMES COOK Fahrtbericht / Cruise Report JC23-A & B: CHILE-MARGIN-SURVEY, OFEG Barter Cruise with SFB 574, 03.03.-25.03. 2008 Valparaiso – Valparaiso, 26.03.-18.04.2008 Valparaiso - Valparaiso, Eds.: Ernst Flüh & Jörg Bialas, 242 pp.
In English |



IFM-GEOMAR

Leibniz-Institut für Meereswissenschaften
an der Universität Kiel

No.

Title

- 21 FS Poseidon Fahrtbericht / Cruise Report P340 – TYMAS "Tyrrenische Massivsulfide", Messina – Messina, 06.07.-17.07.2006, Eds.: Sven Petersen and Thomas Monecke, 77 pp.
In English
- 22 RV Atalante Fahrtbericht / Cruise Report HYDROMAR V (replacement of cruise MSM06/2), Toulon, France - Recife, Brazil, 04.12.2007 - 02.01.2008, Ed.: Sven Petersen, 103 pp.
In English



IFM-GEOMAR

Leibniz-Institut für Meereswissenschaften
an der Universität Kiel

Das Leibniz-Institut für Meereswissenschaften
ist ein Institut der Wissenschaftsgemeinschaft
Gottfried Wilhelm Leibniz (WGL)

The Leibniz-Institute of Marine Sciences is a
member of the Leibniz Association
(Wissenschaftsgemeinschaft Gottfried
Wilhelm Leibniz).

Leibniz-Institut für Meereswissenschaften / Leibniz-Institute of Marine Sciences

IFM-GEOMAR
Dienstgebäude Westufer / West Shore Building
Düsternbrooker Weg 20
D-24105 Kiel
Germany

Leibniz-Institut für Meereswissenschaften / Leibniz-Institute of Marine Sciences

IFM-GEOMAR
Dienstgebäude Ostufer / East Shore Building
Wischhofstr. 1-3
D-24148 Kiel
Germany

Tel.: ++49 431 600-0
Fax: ++49 431 600-2805
www.ifm-geomar.de